

TENE

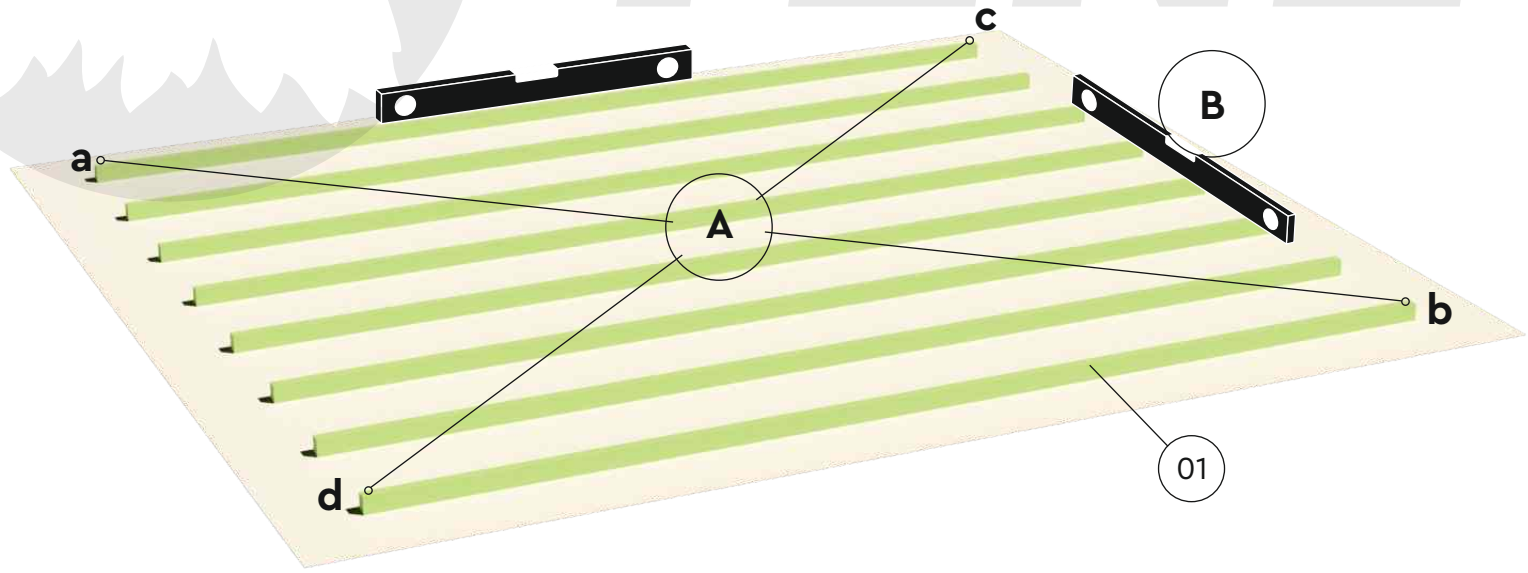

CLARA 28

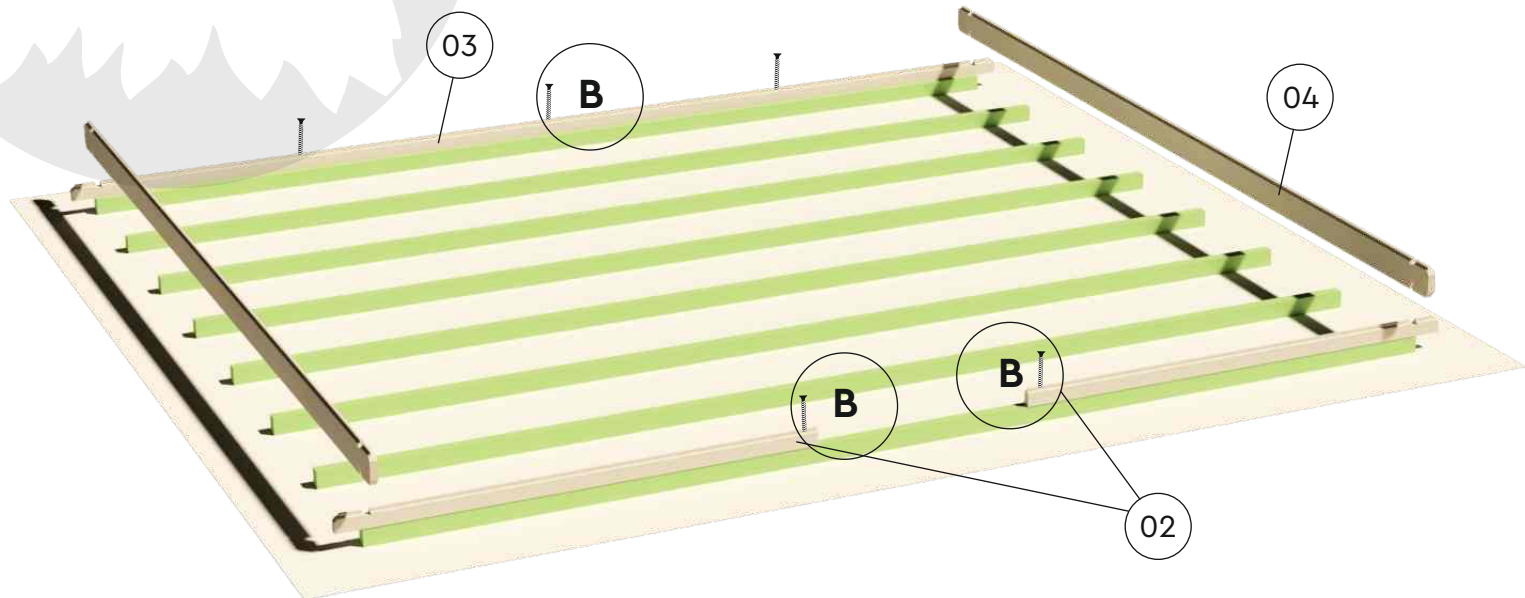
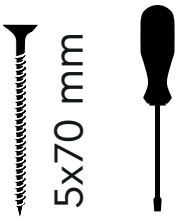
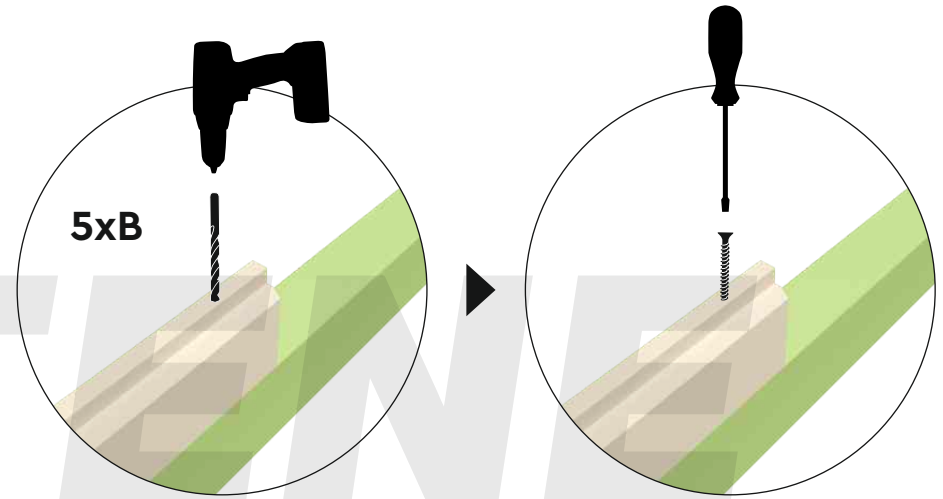
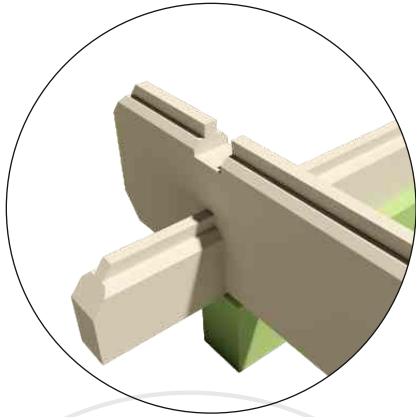

CLARA 28

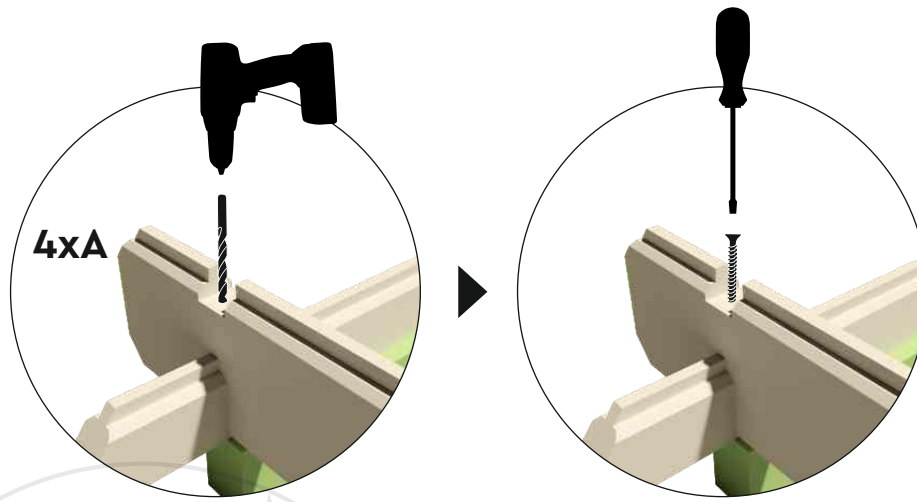

Ø 5 mm

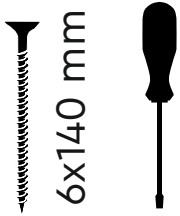

6x140 mm



TENNE

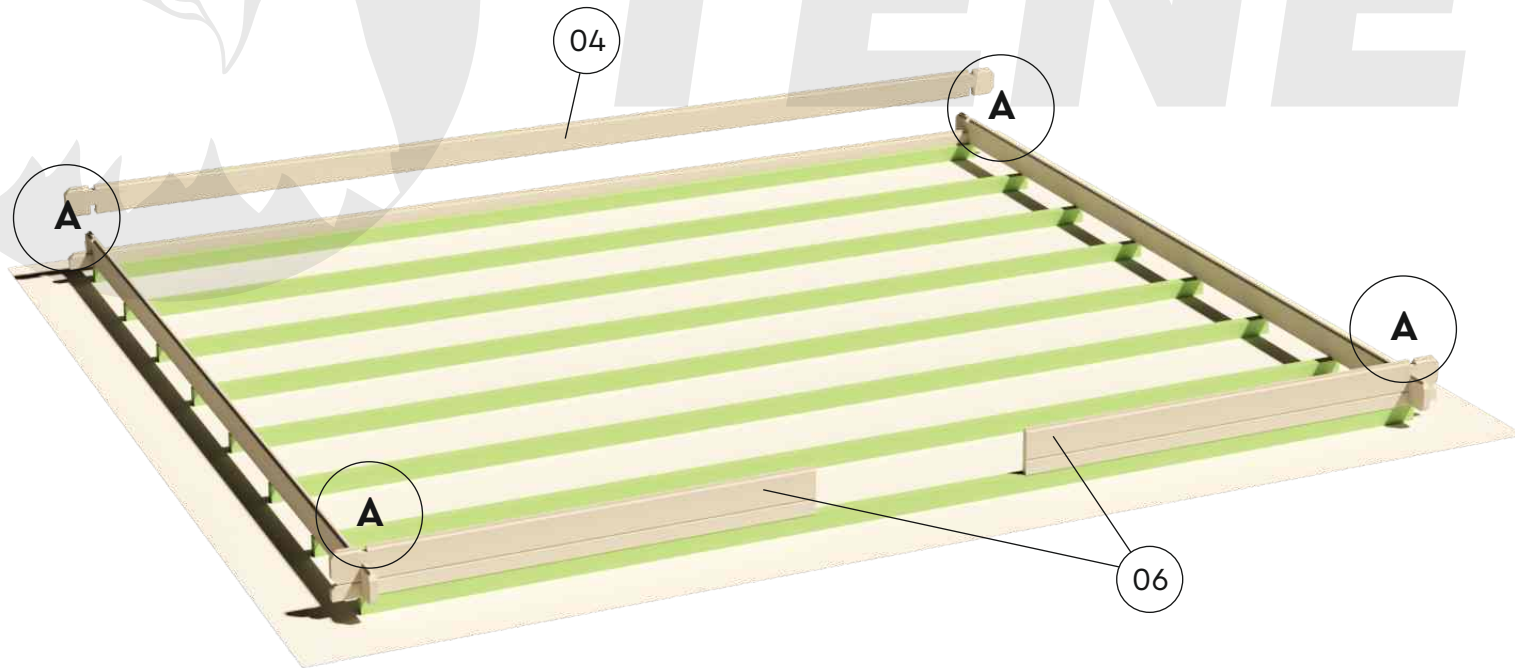

CLARA 28

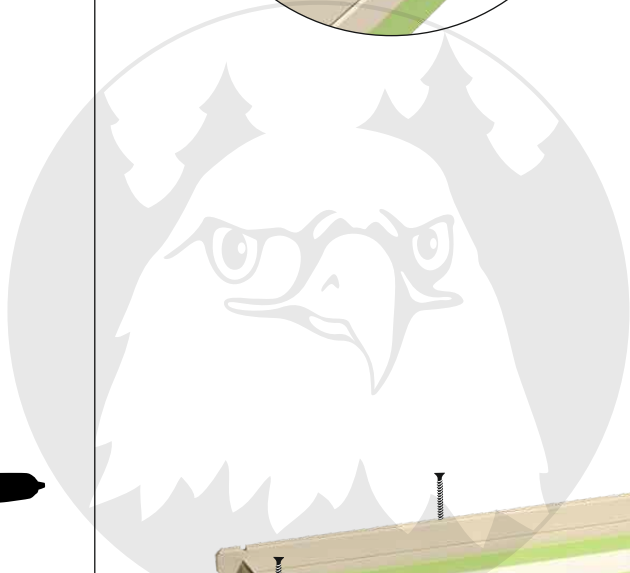
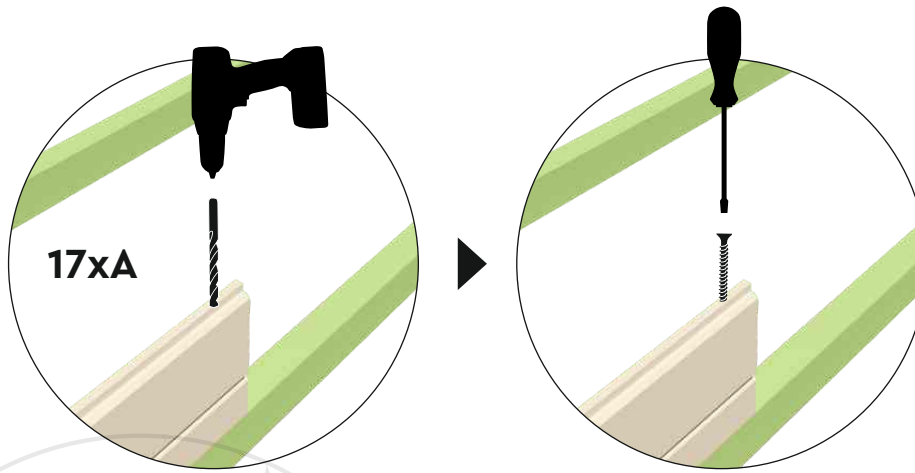

TENE

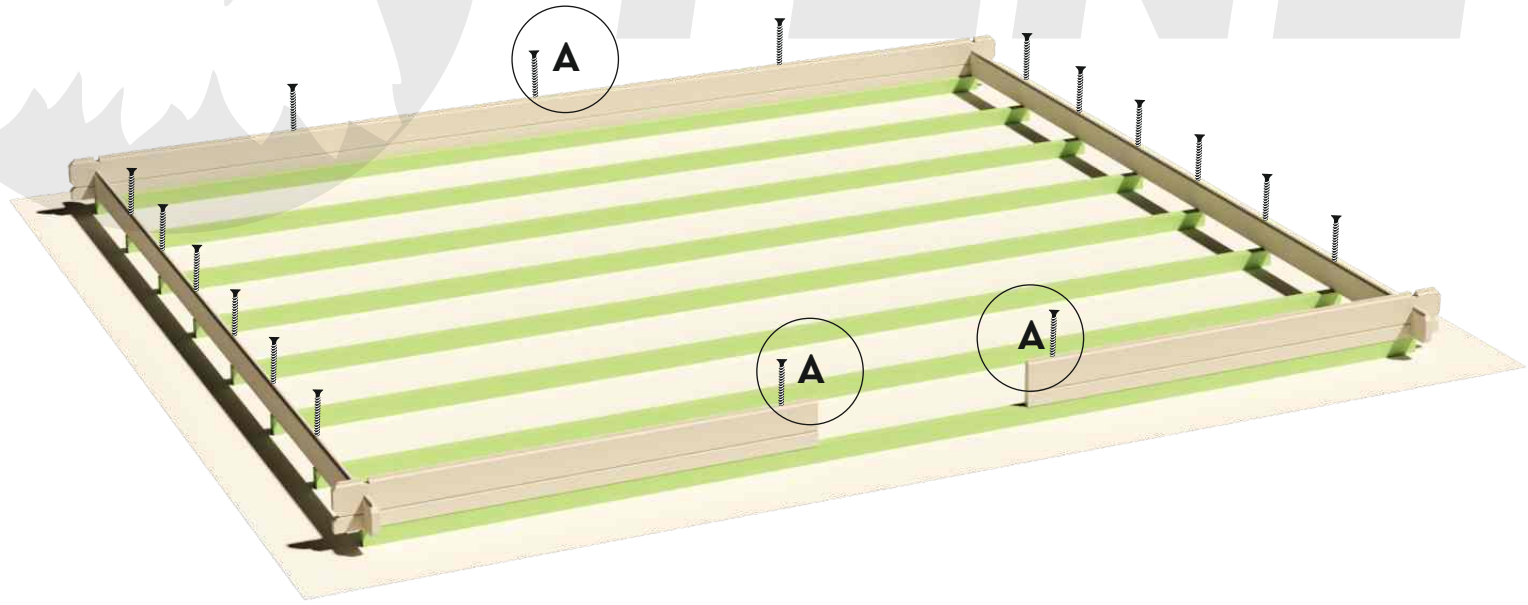
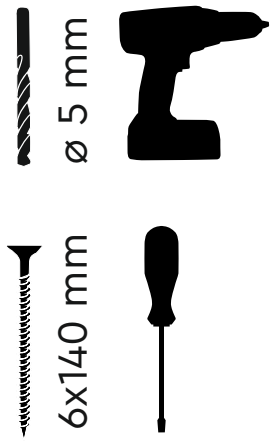

CLARA 28

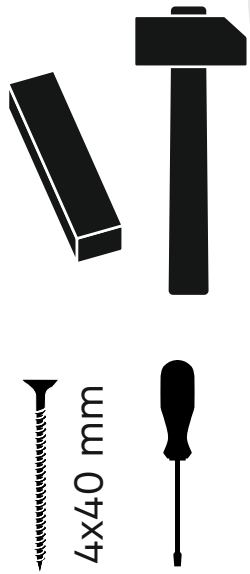
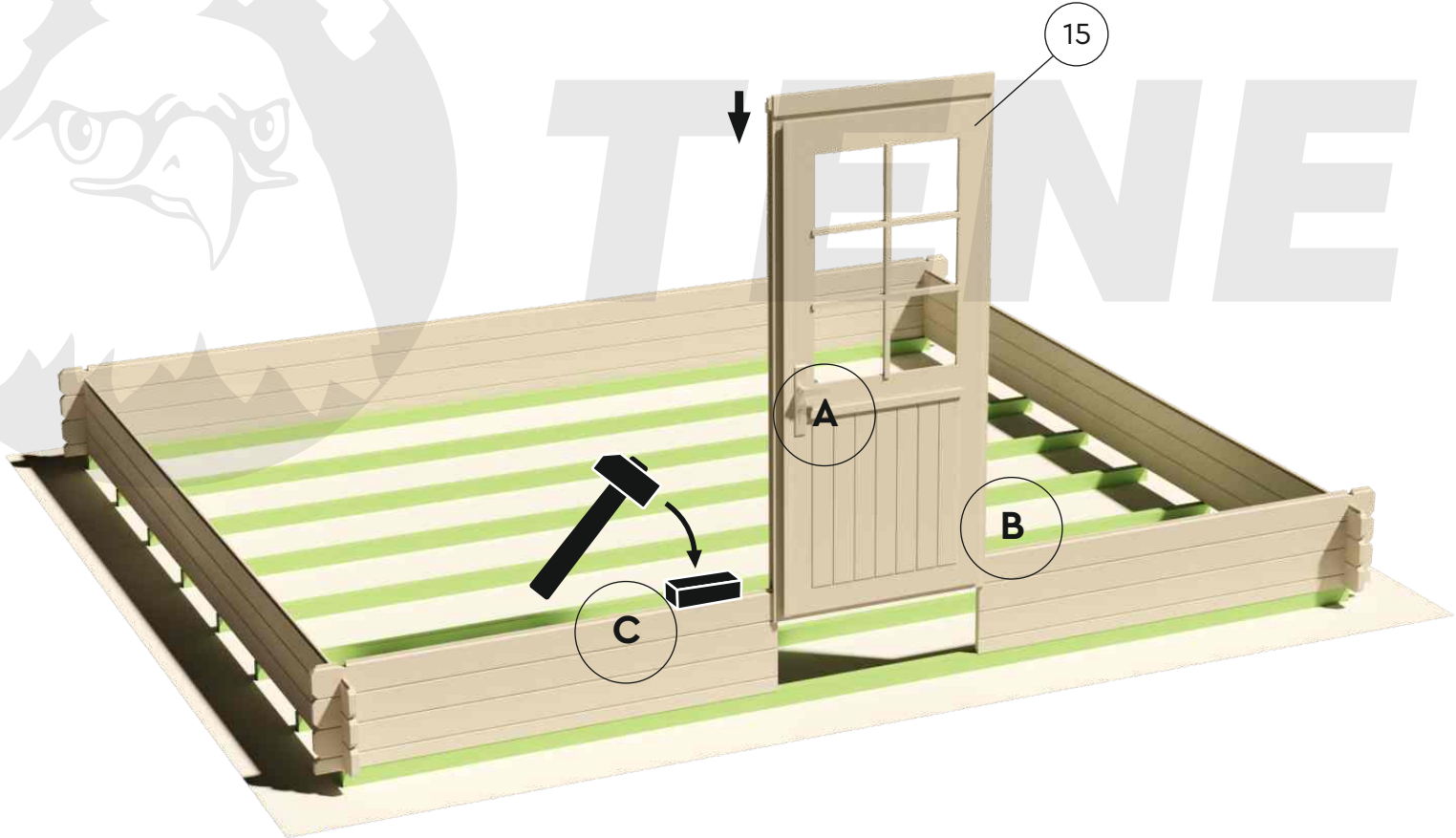
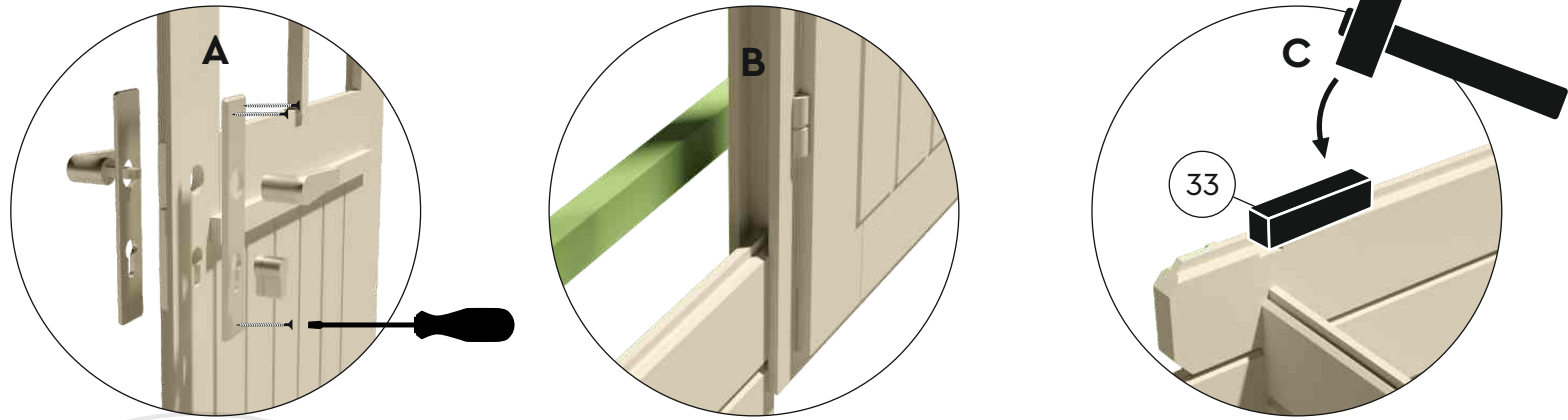

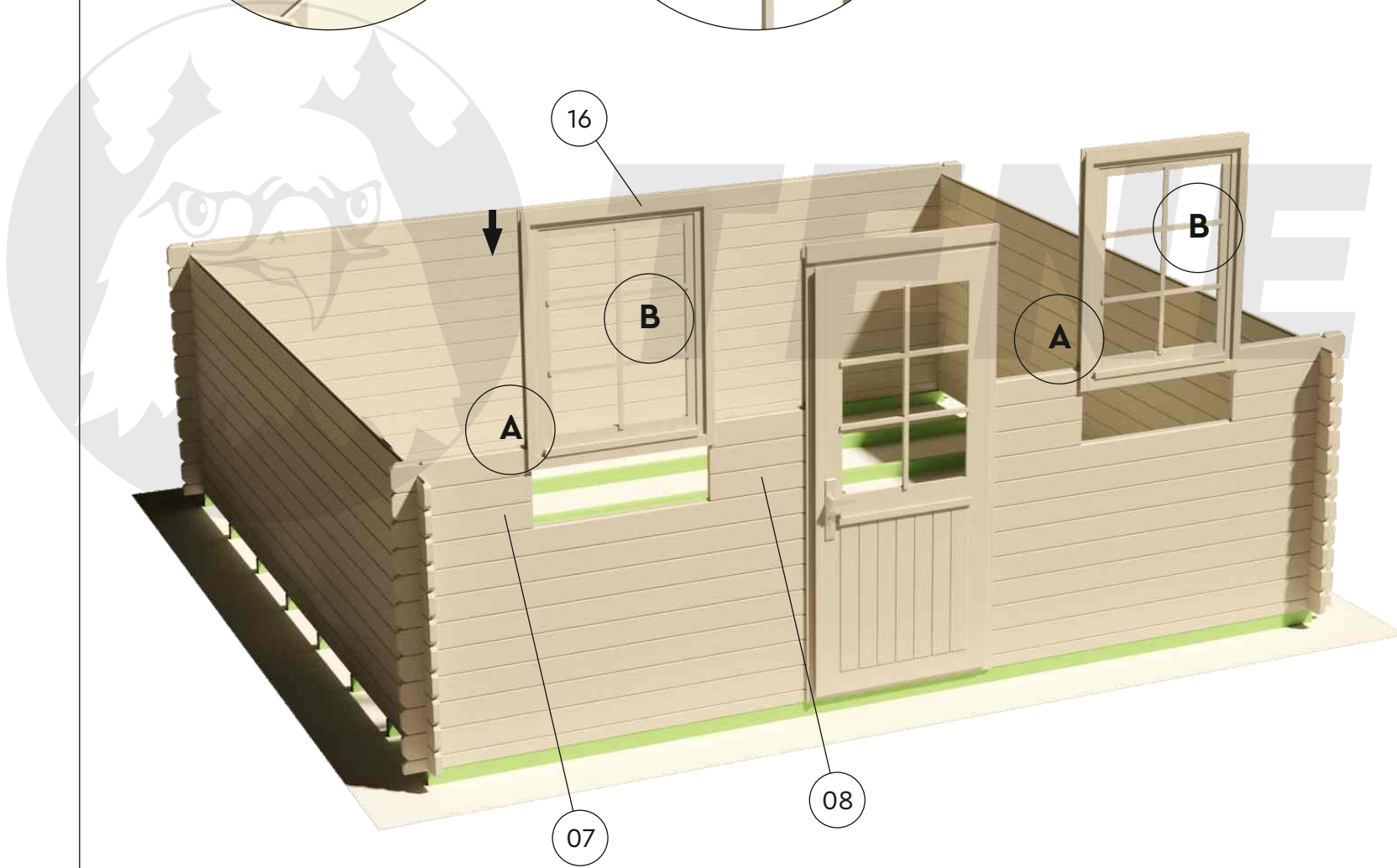
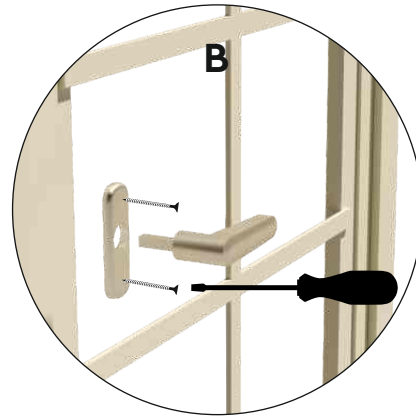
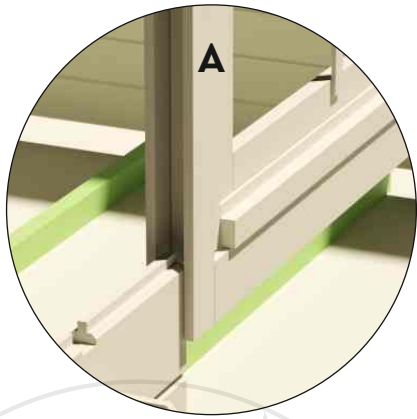

CLARA 28

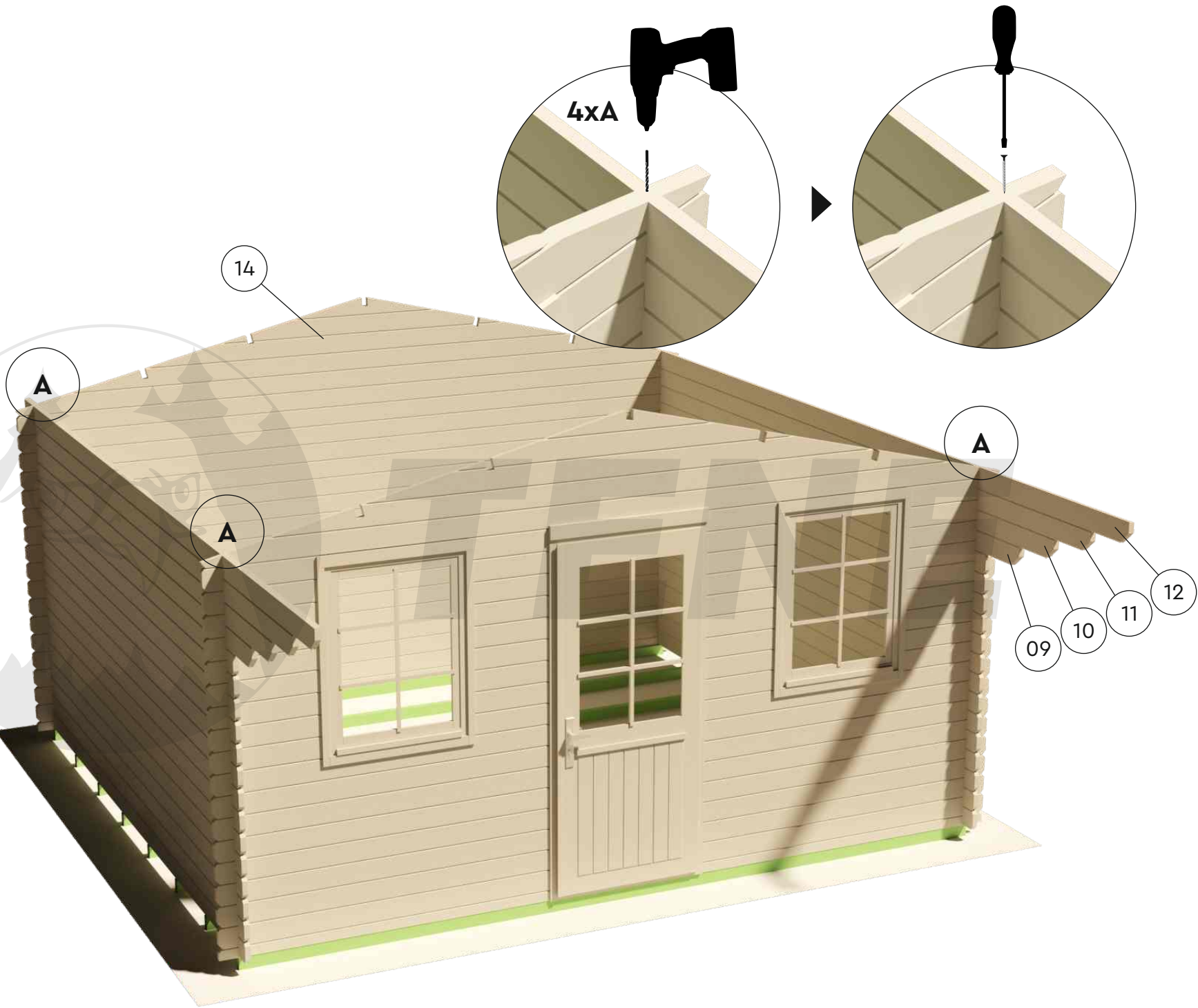
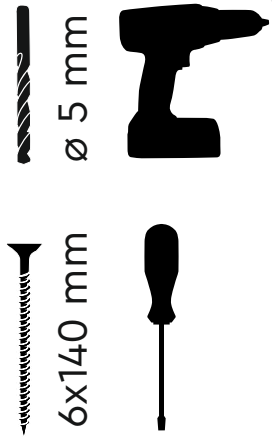

CLARA 28

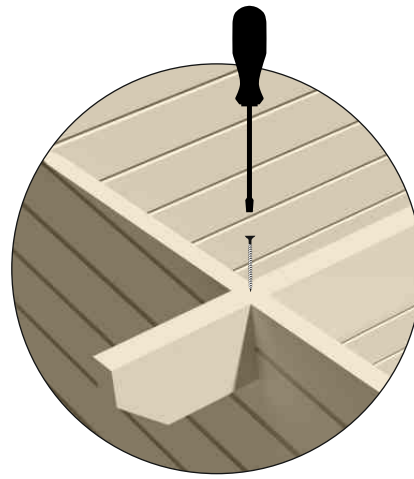
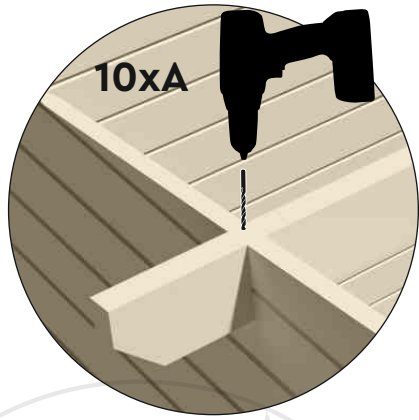

Ø 5 mm

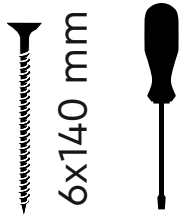

6x140 mm

CLARA 28

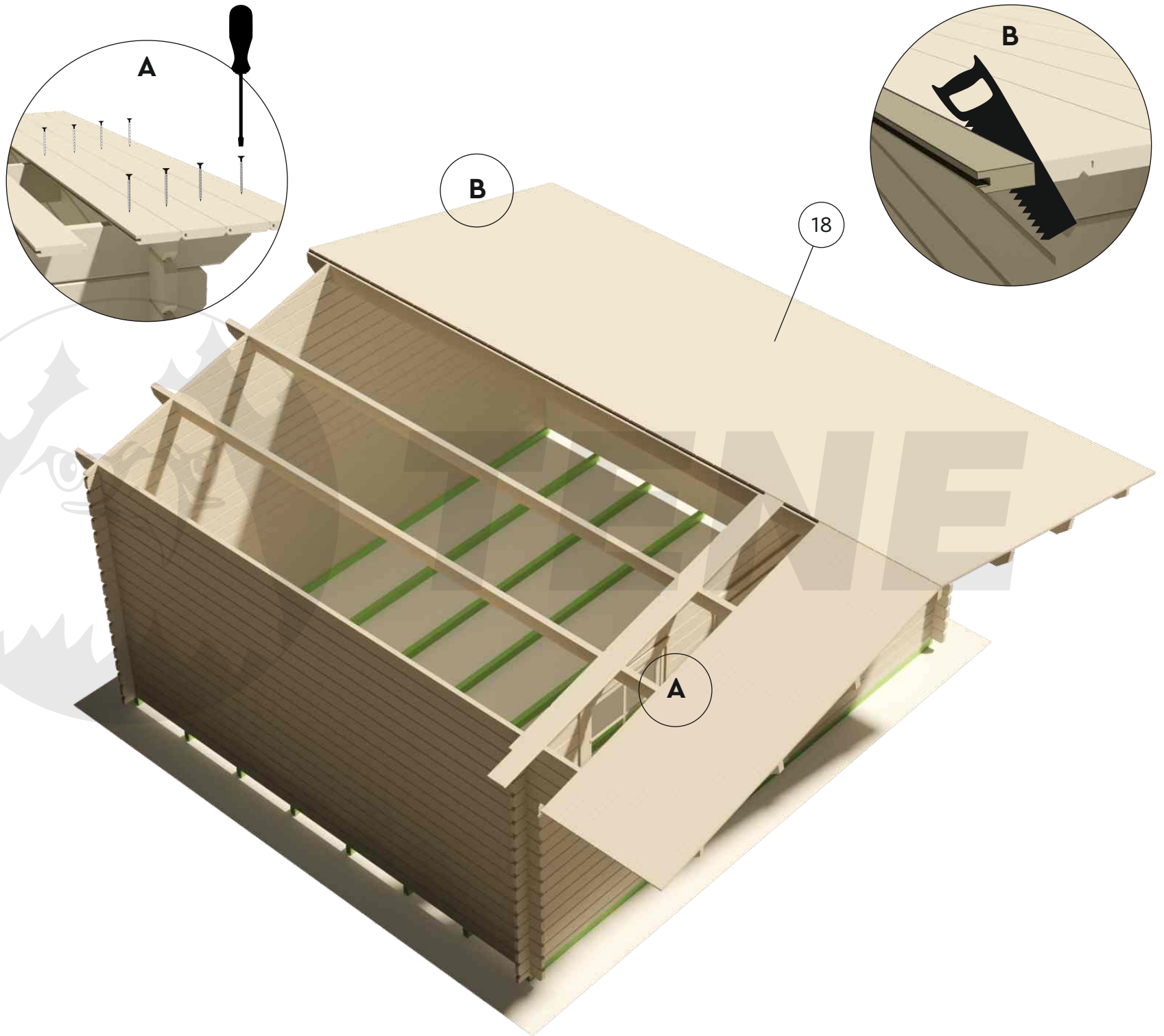

4x50 mm



CLARA 28

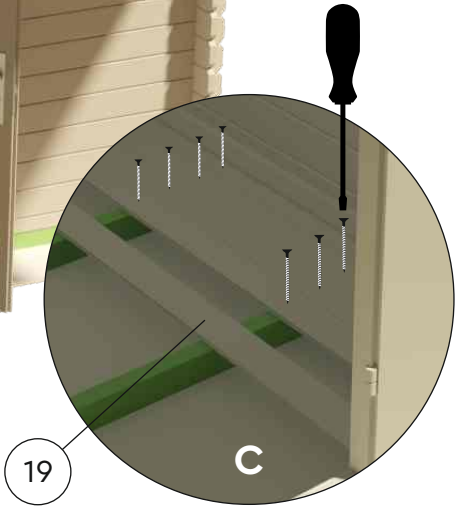
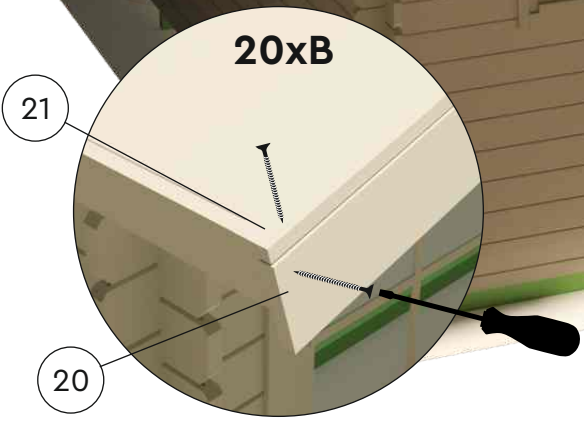
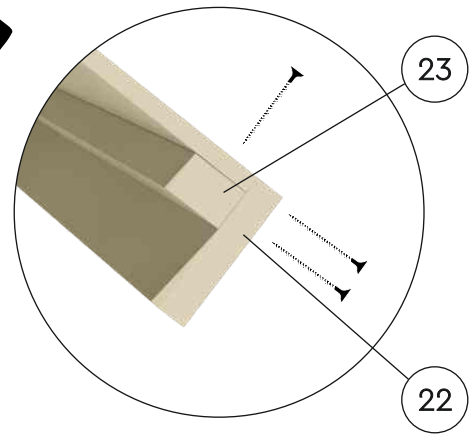
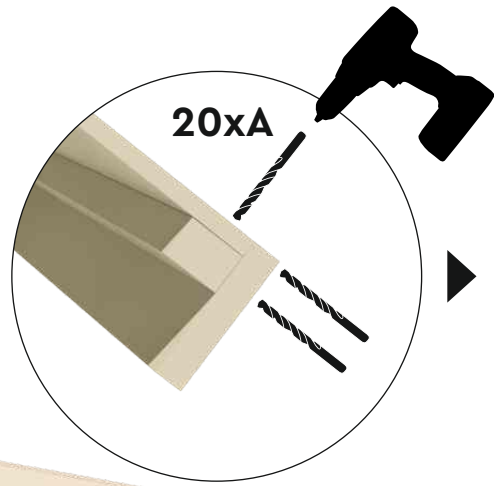
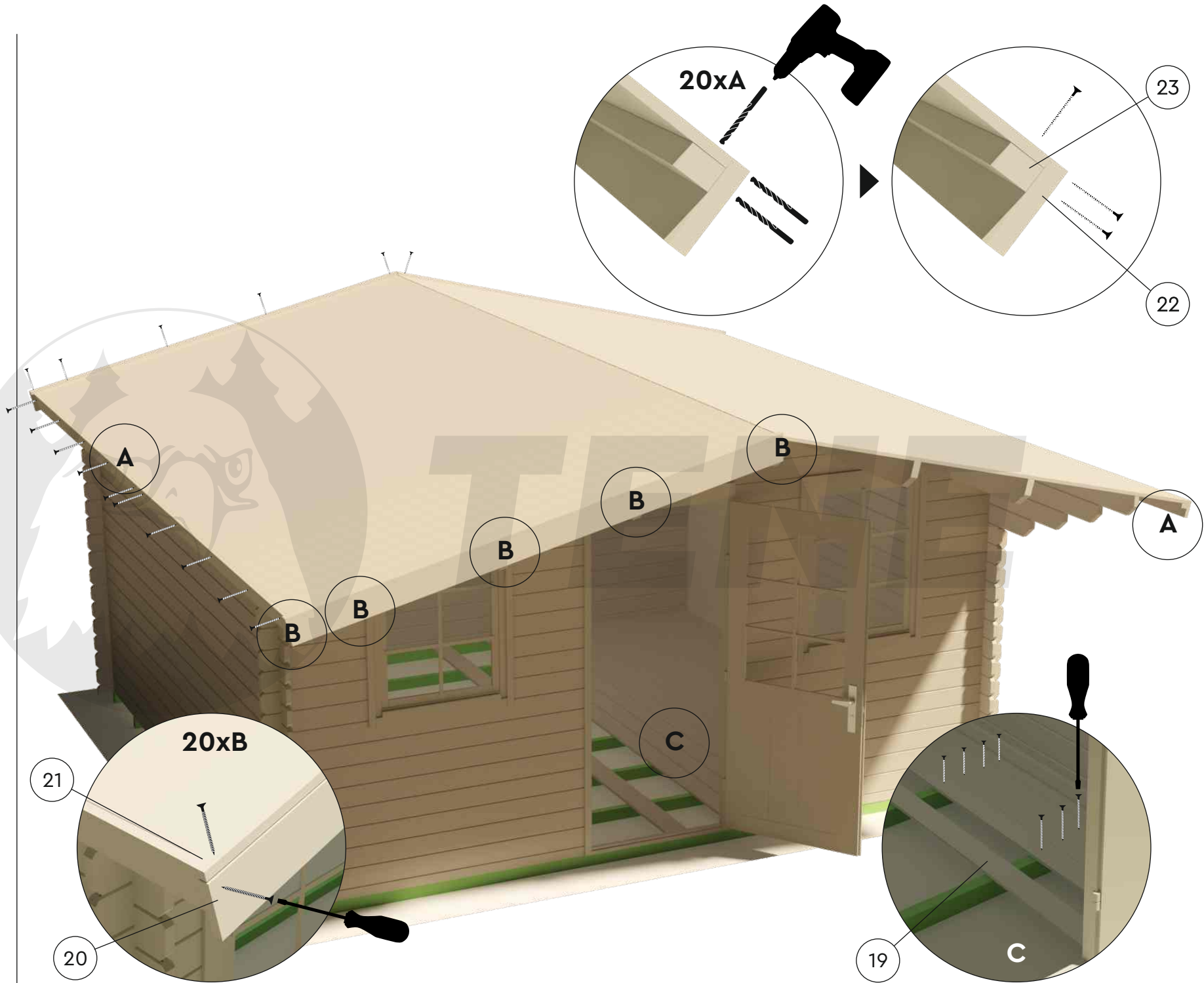
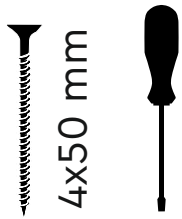

CLARA 28

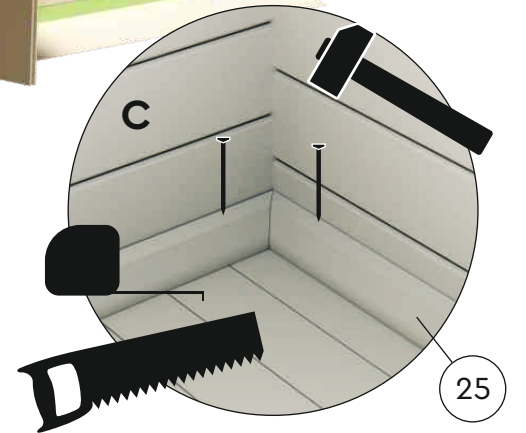
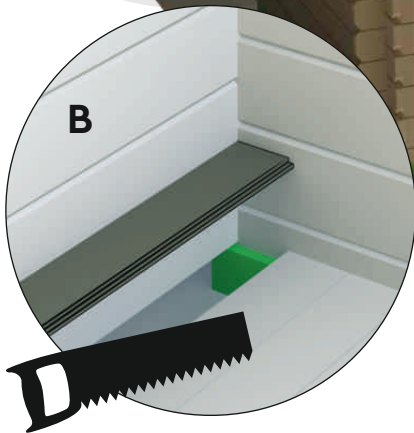
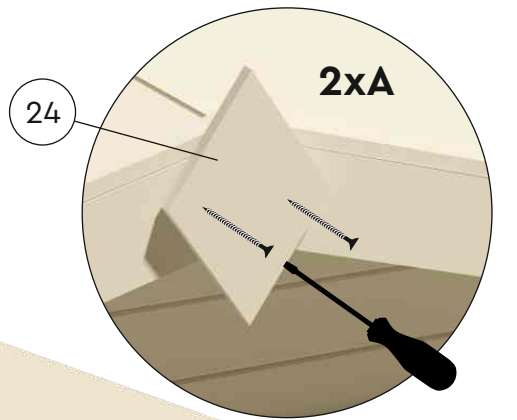
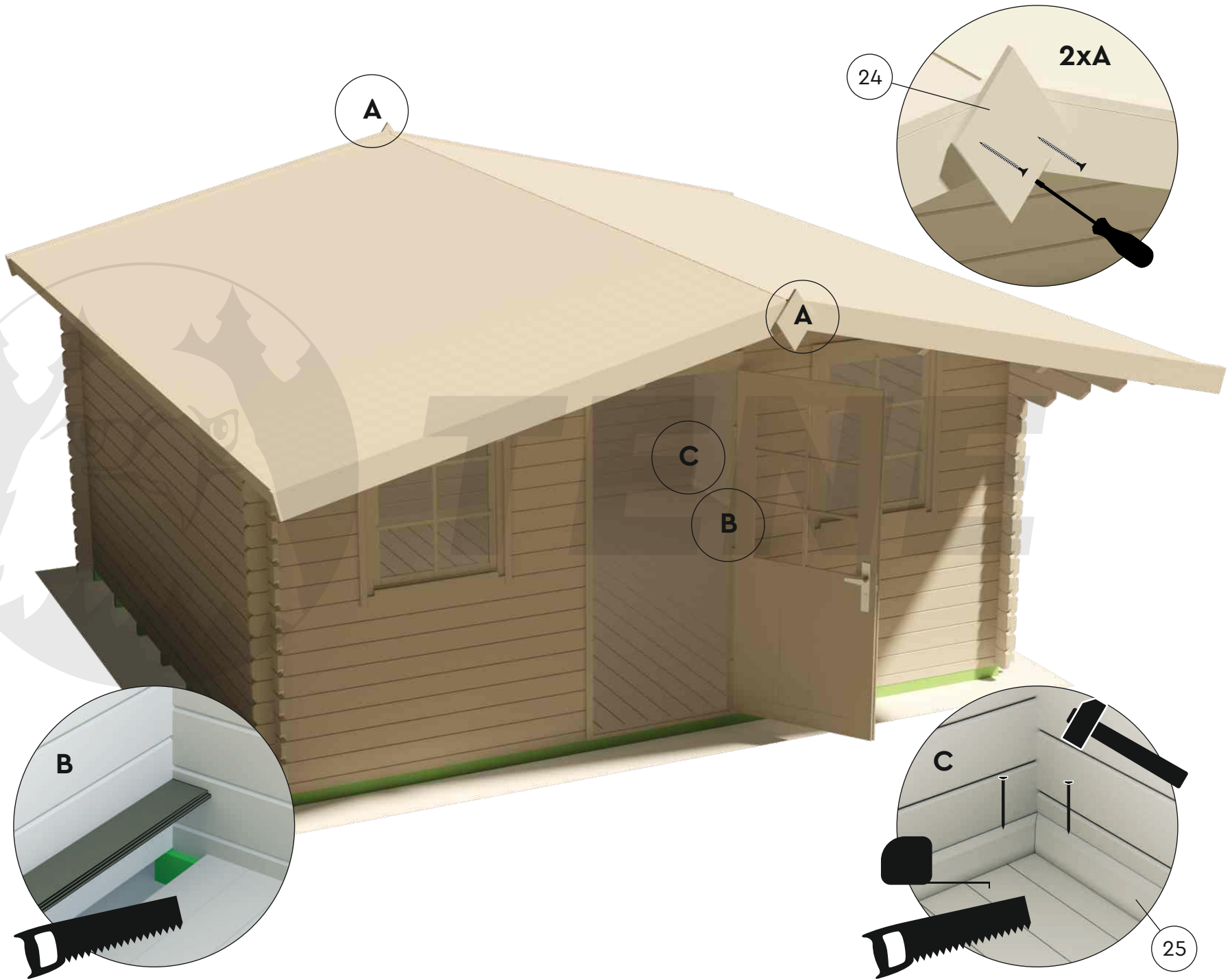
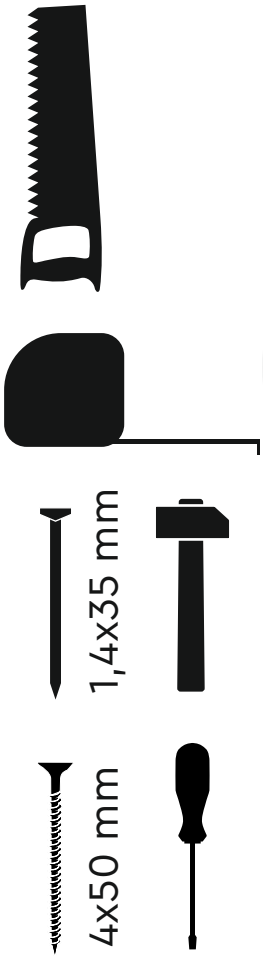

CLARA 28

