

CABRIEL A 28

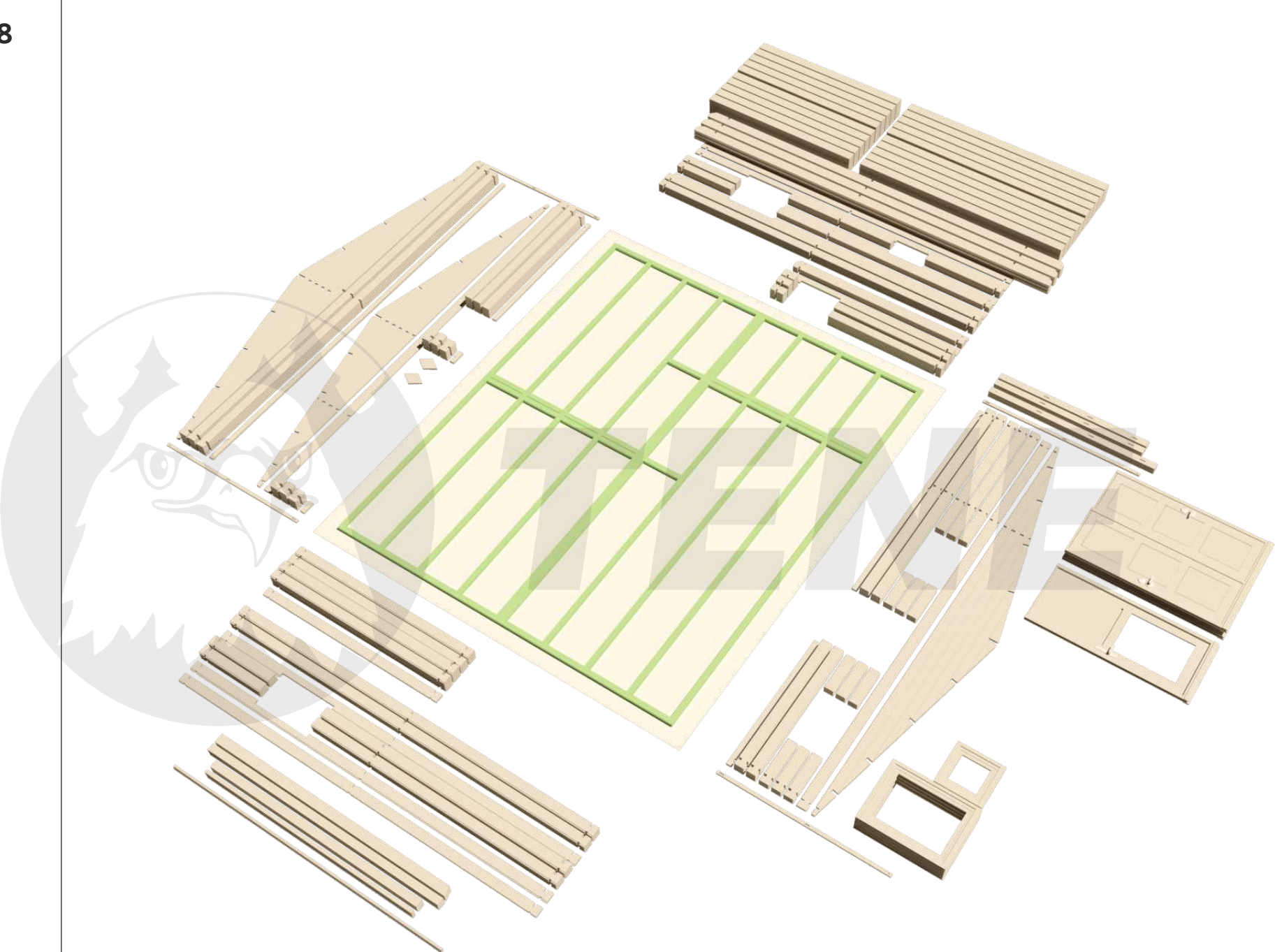

CABRIEL A 28

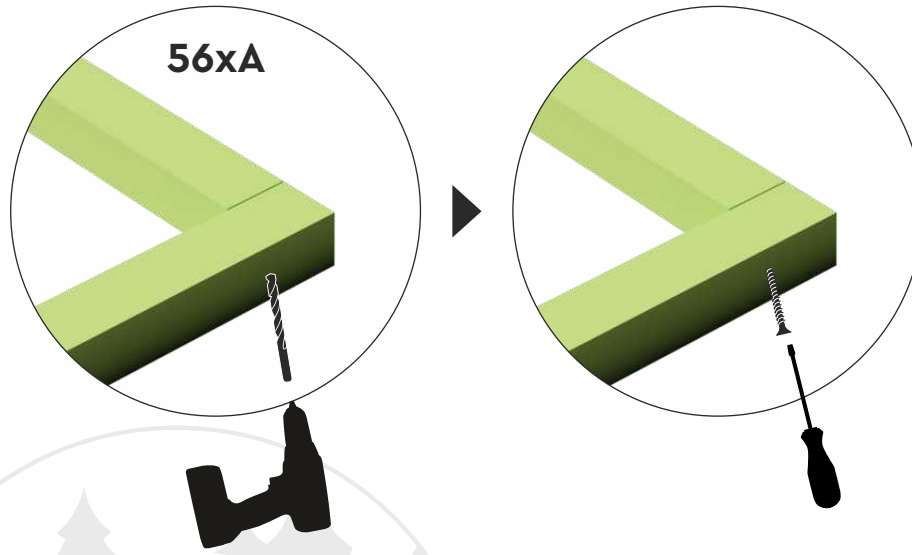

Ø 5 mm

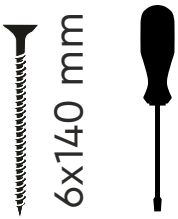

6x140 mm

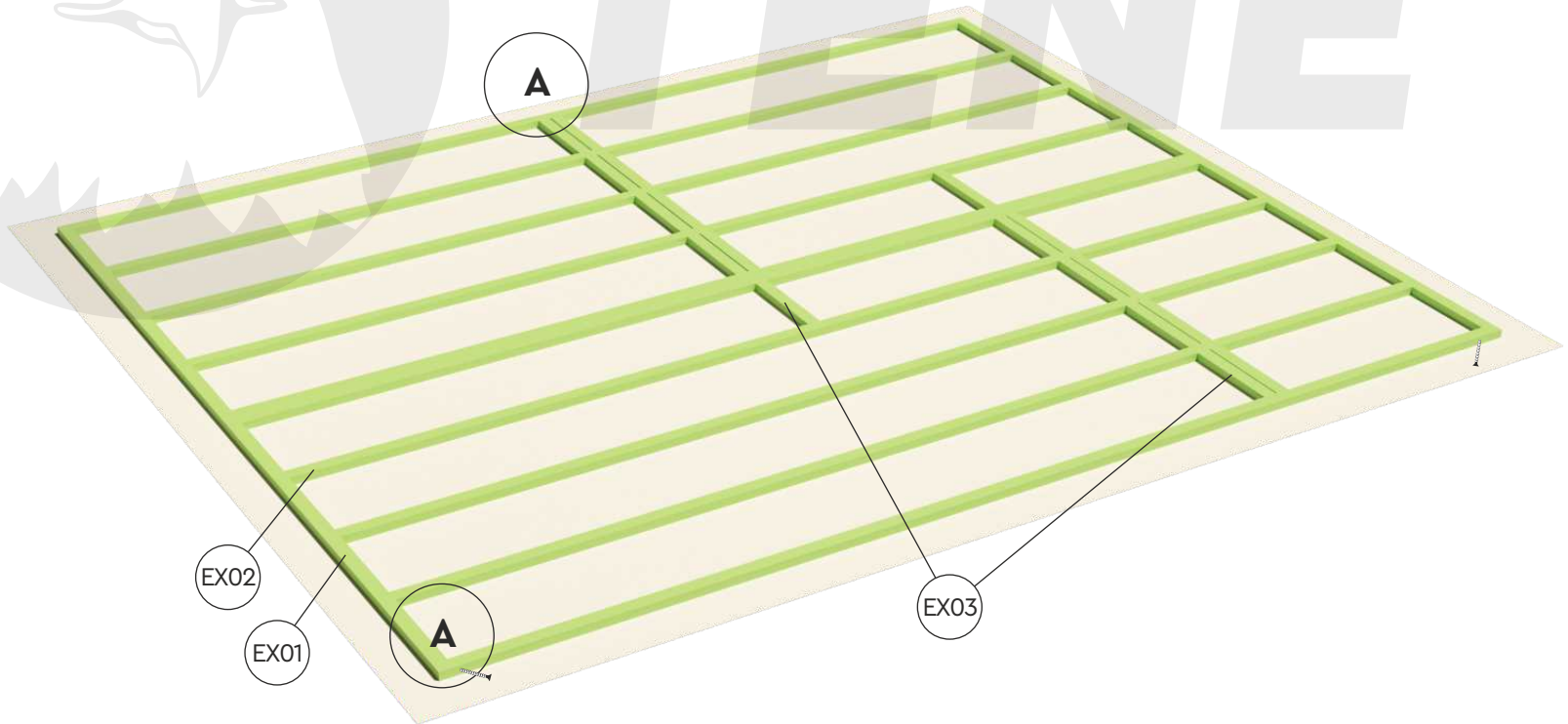

TENE

CABRIEL A 28

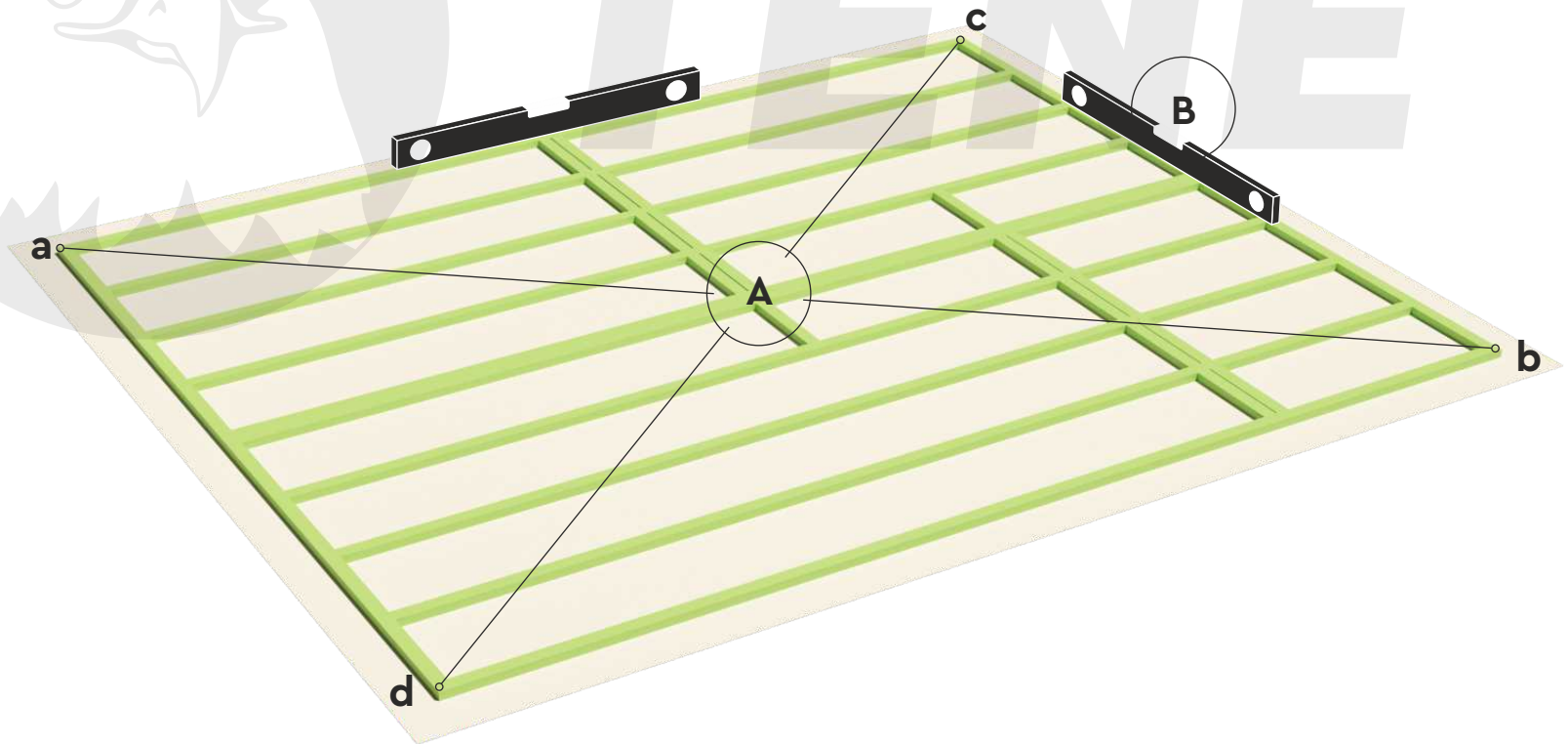
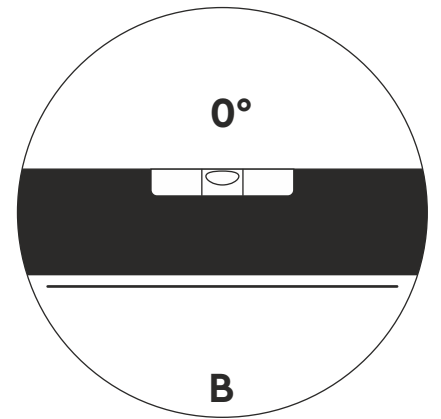
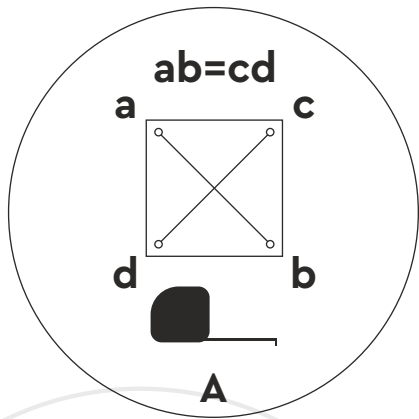

CABRIEL A 28

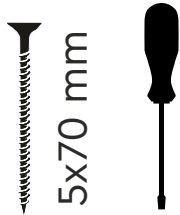
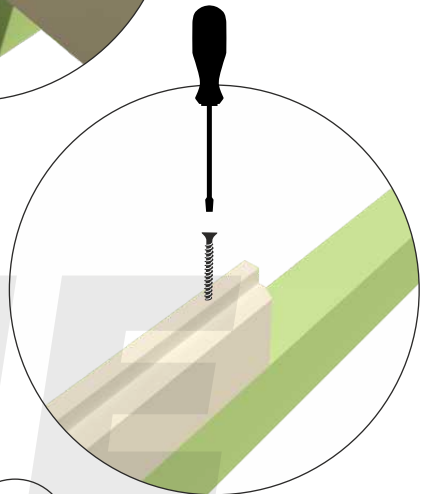
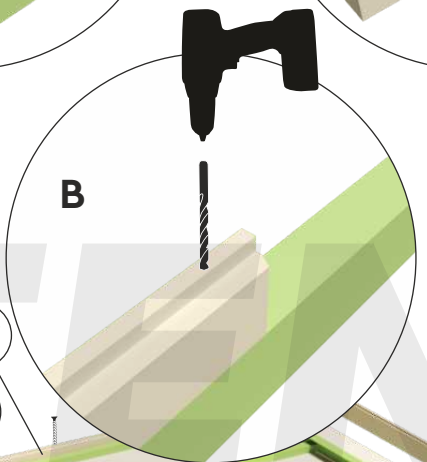
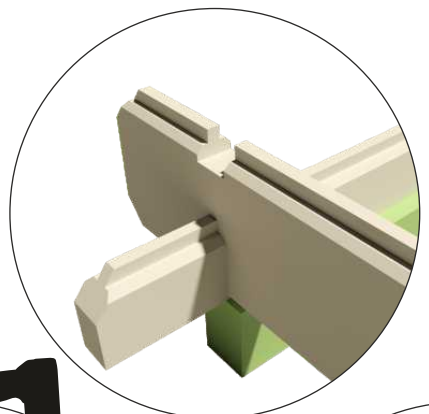
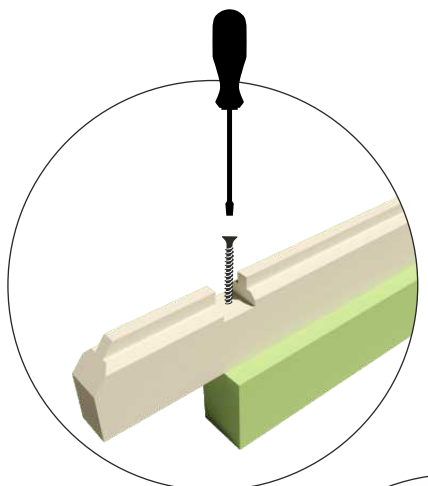
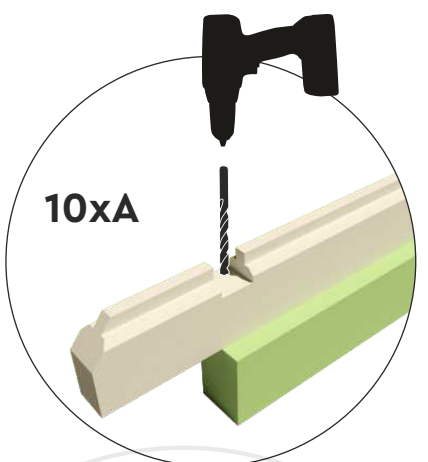
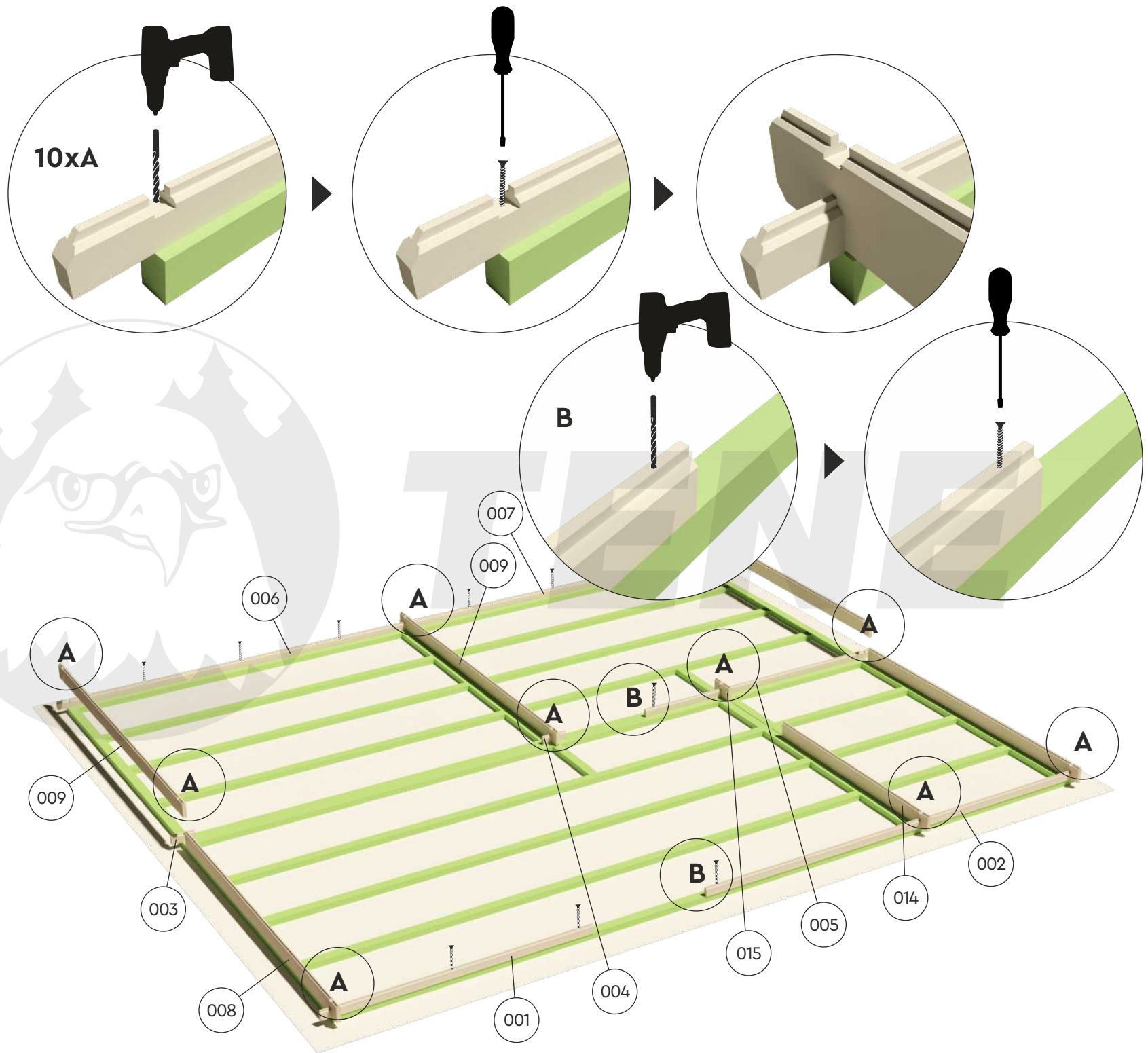

CABRIEL A 28

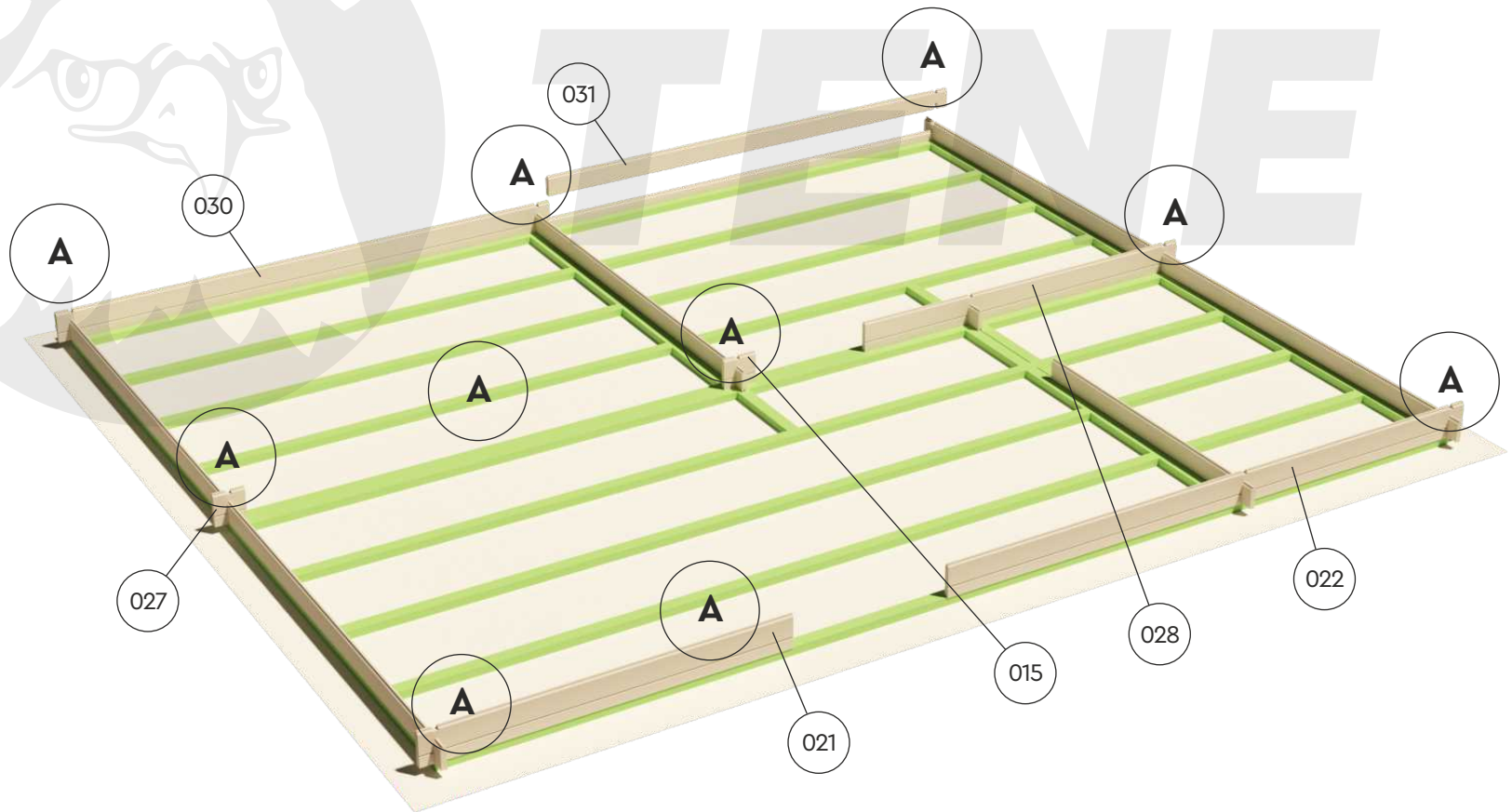
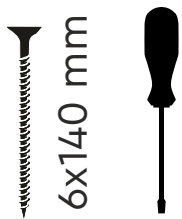
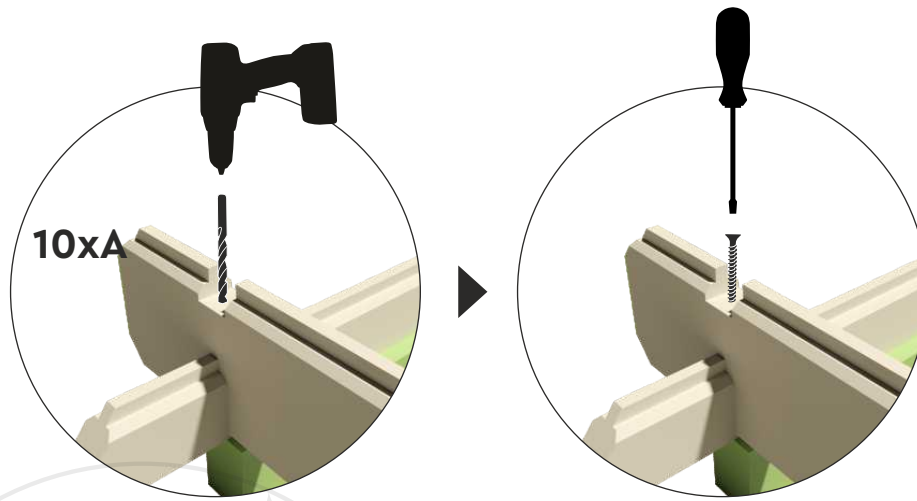

CABRIEL A 28

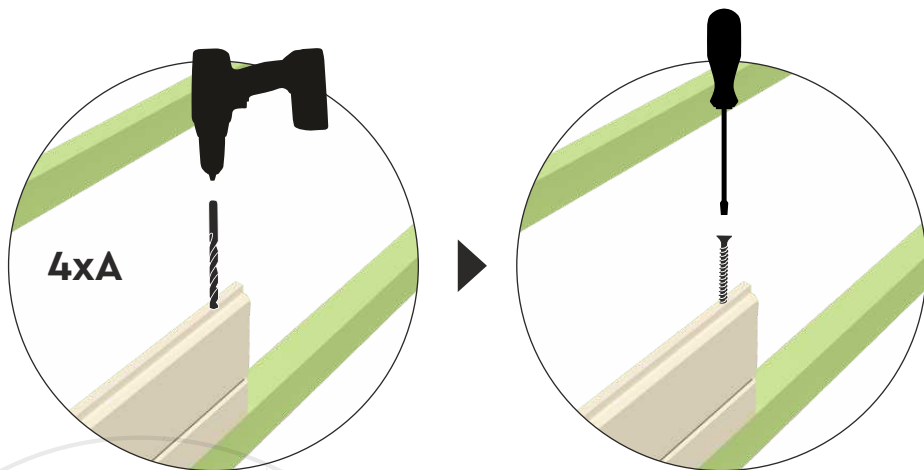

Ø 5 mm

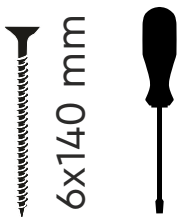

6x140 mm

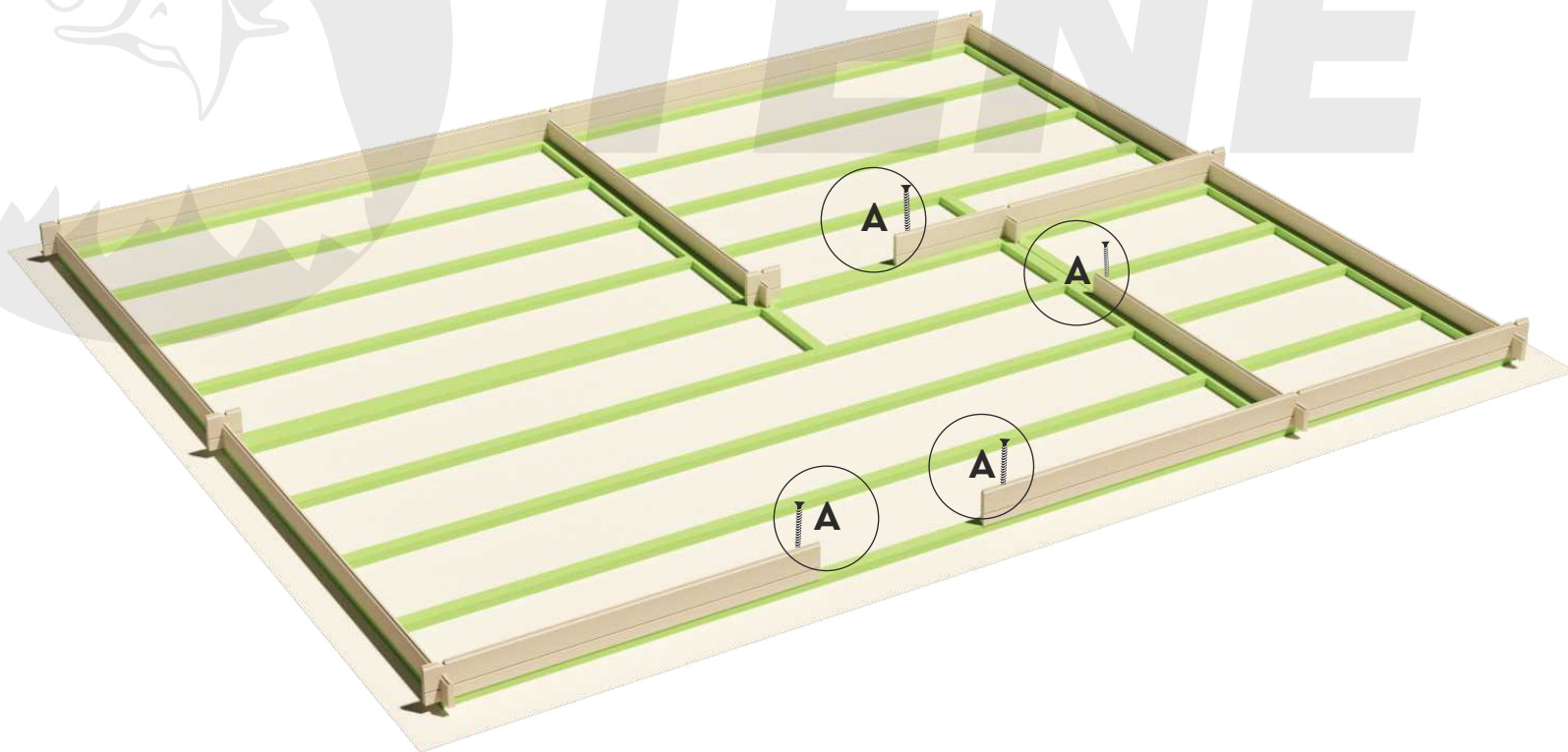

CABRIEL A 28

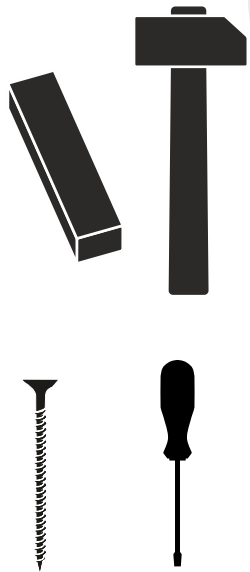
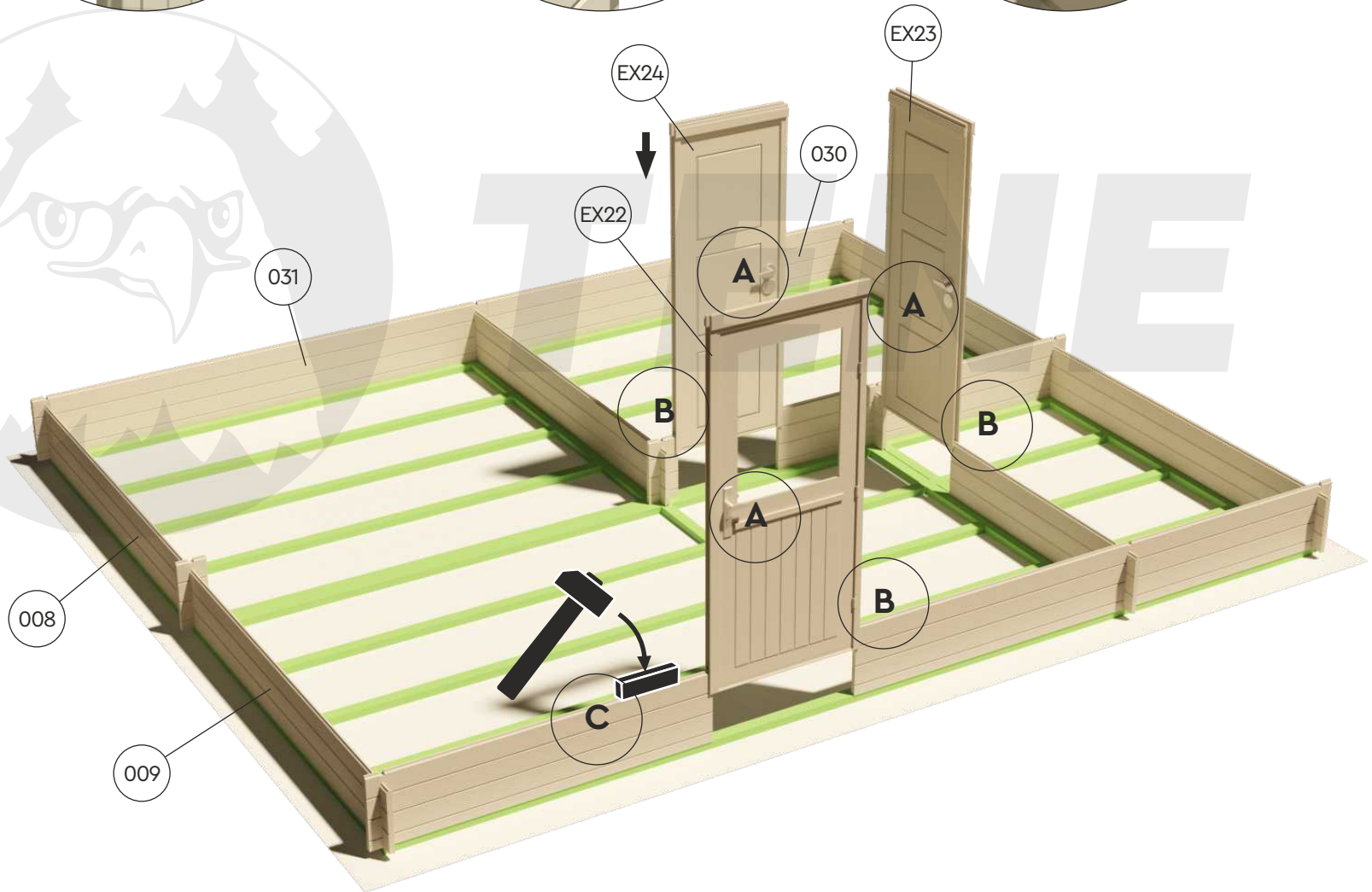
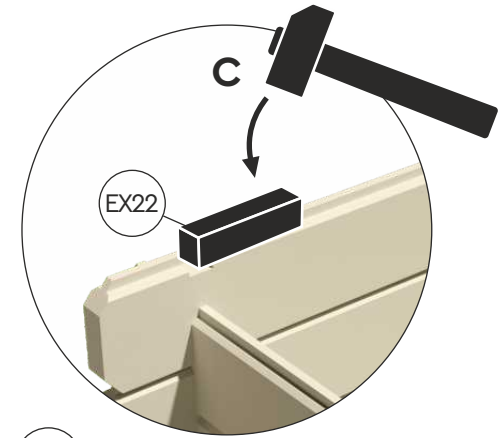
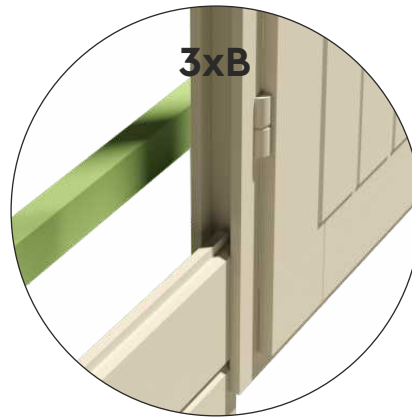
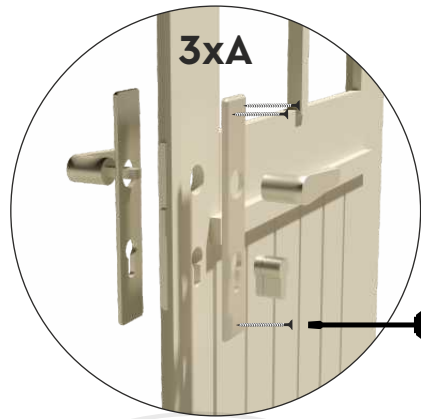

CABRIEL A 28

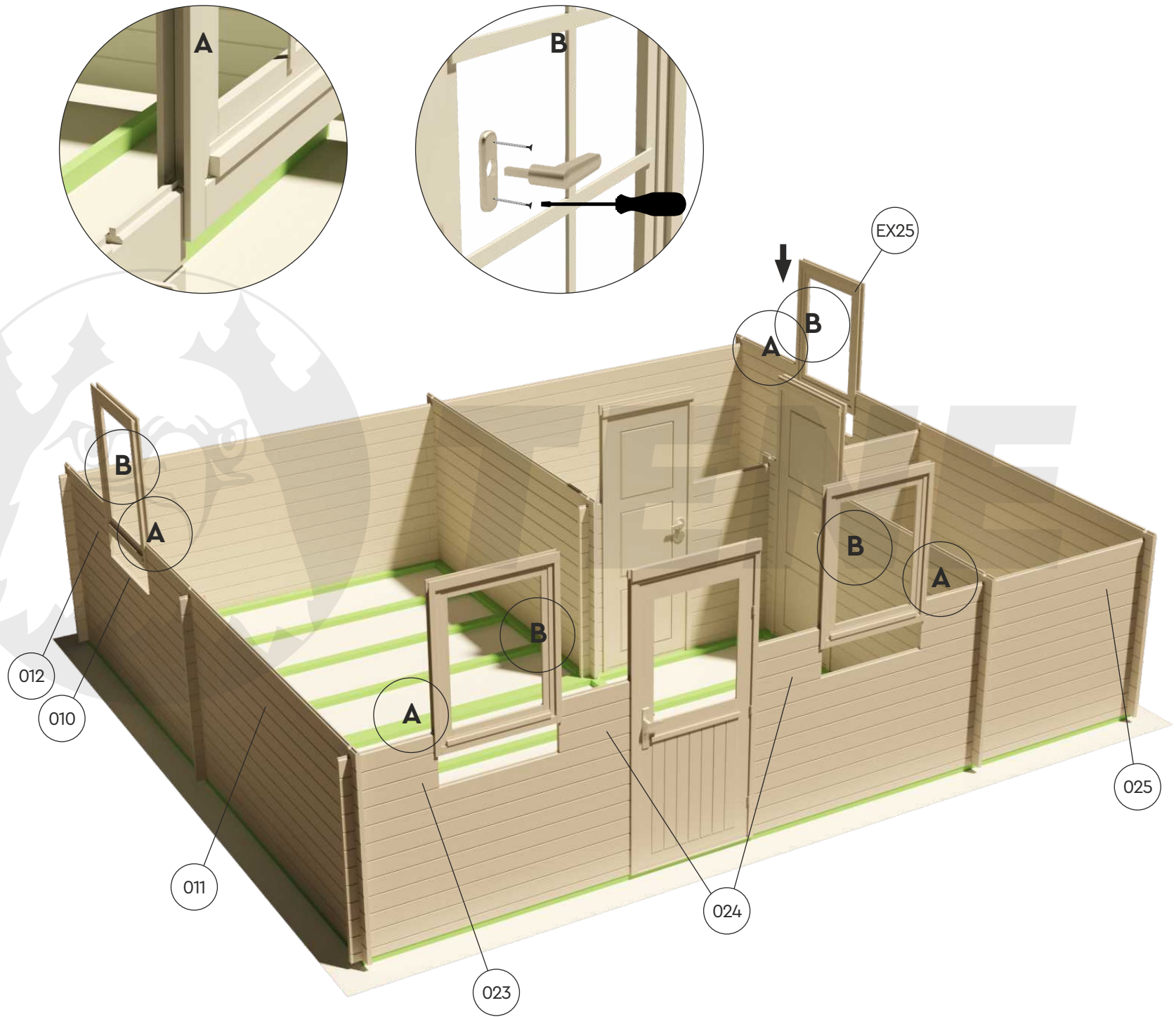

CABRIEL A 28

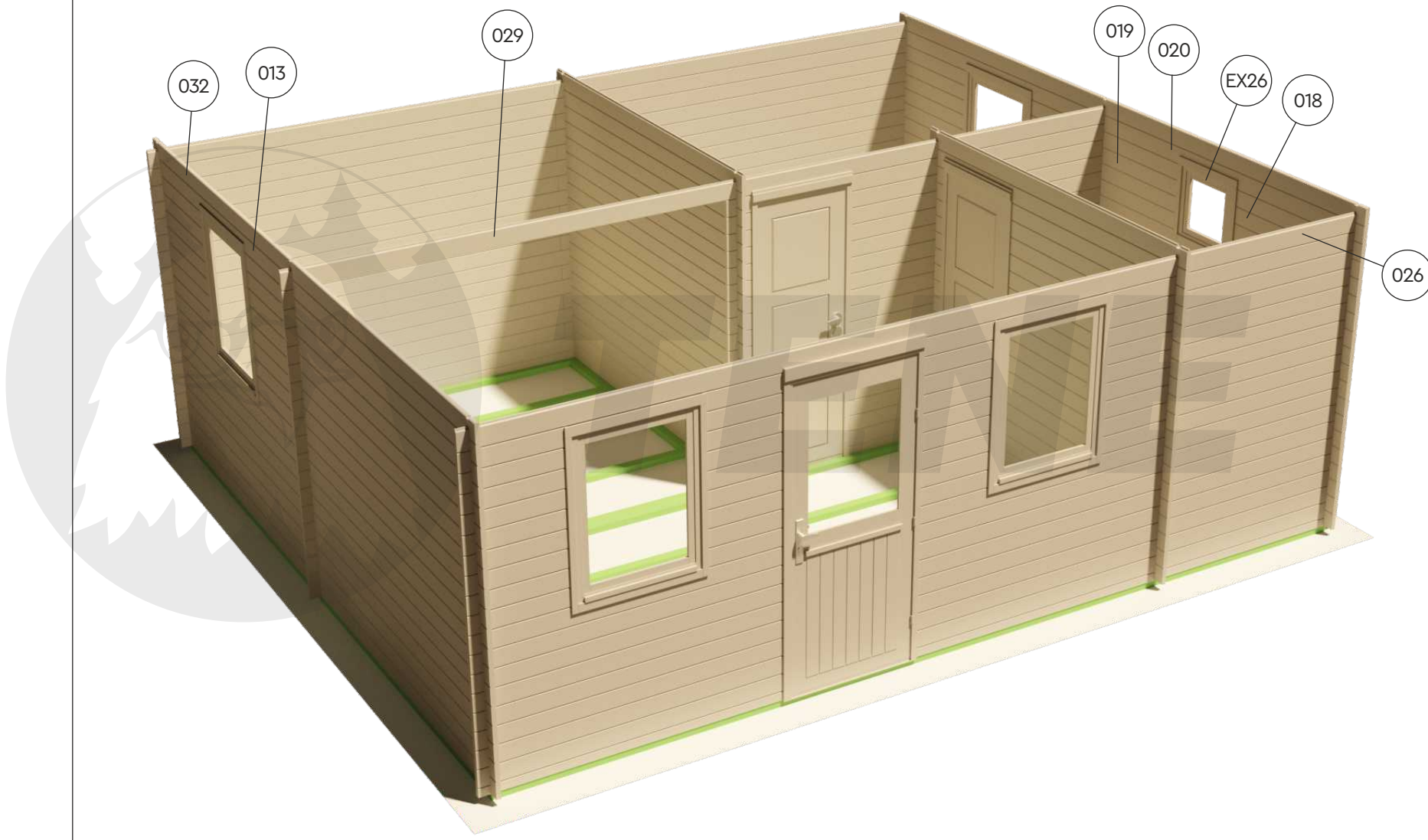

CABRIEL A 28

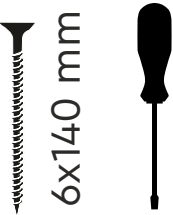
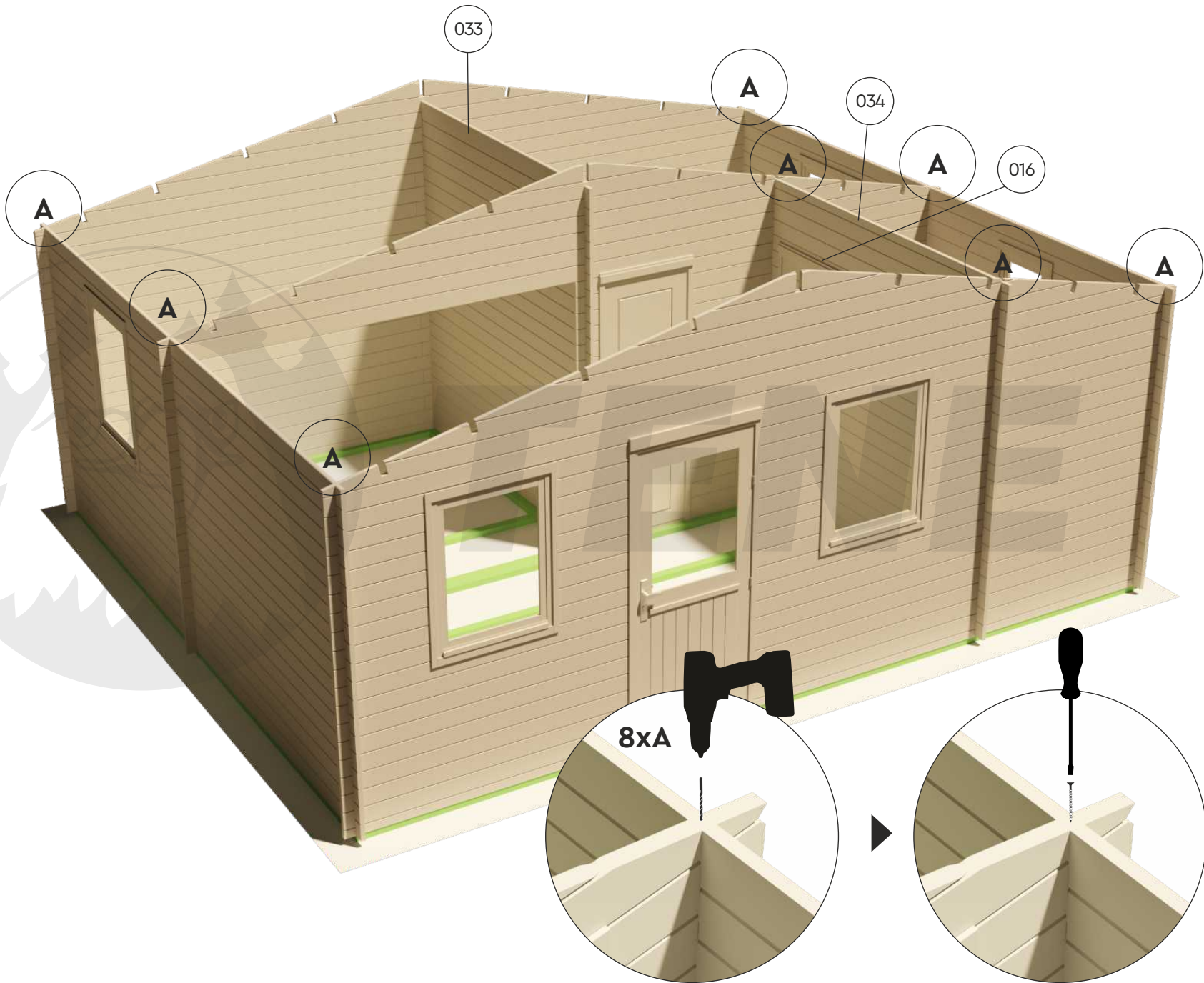

CABRIEL A 28

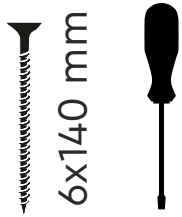
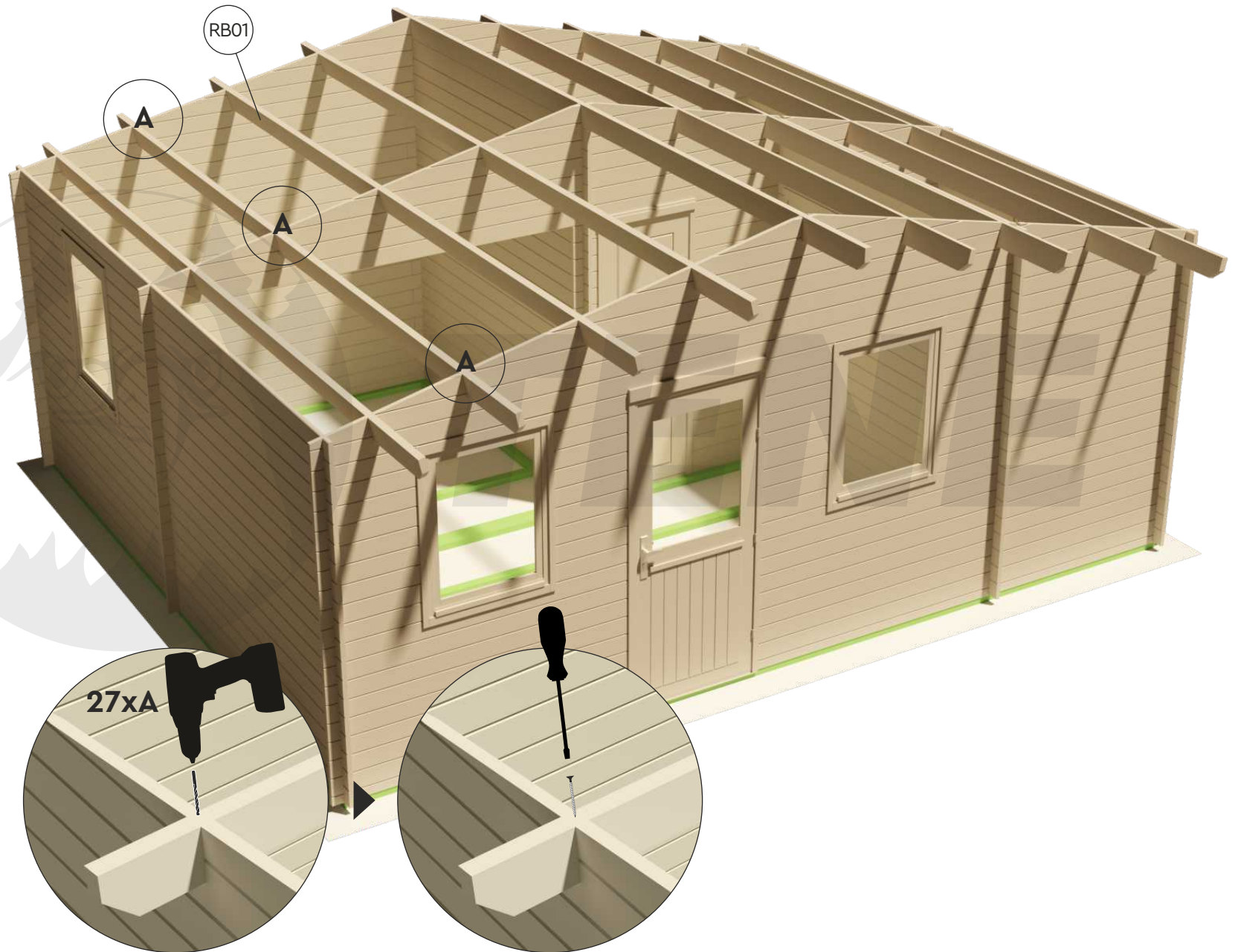

CABRIEL A 28

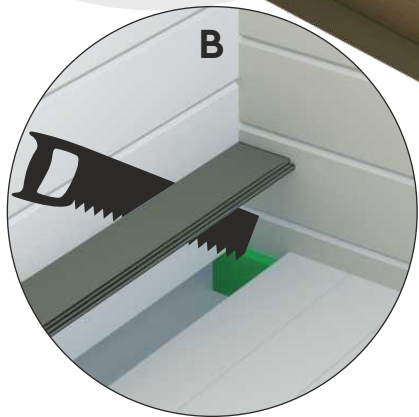
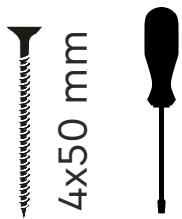
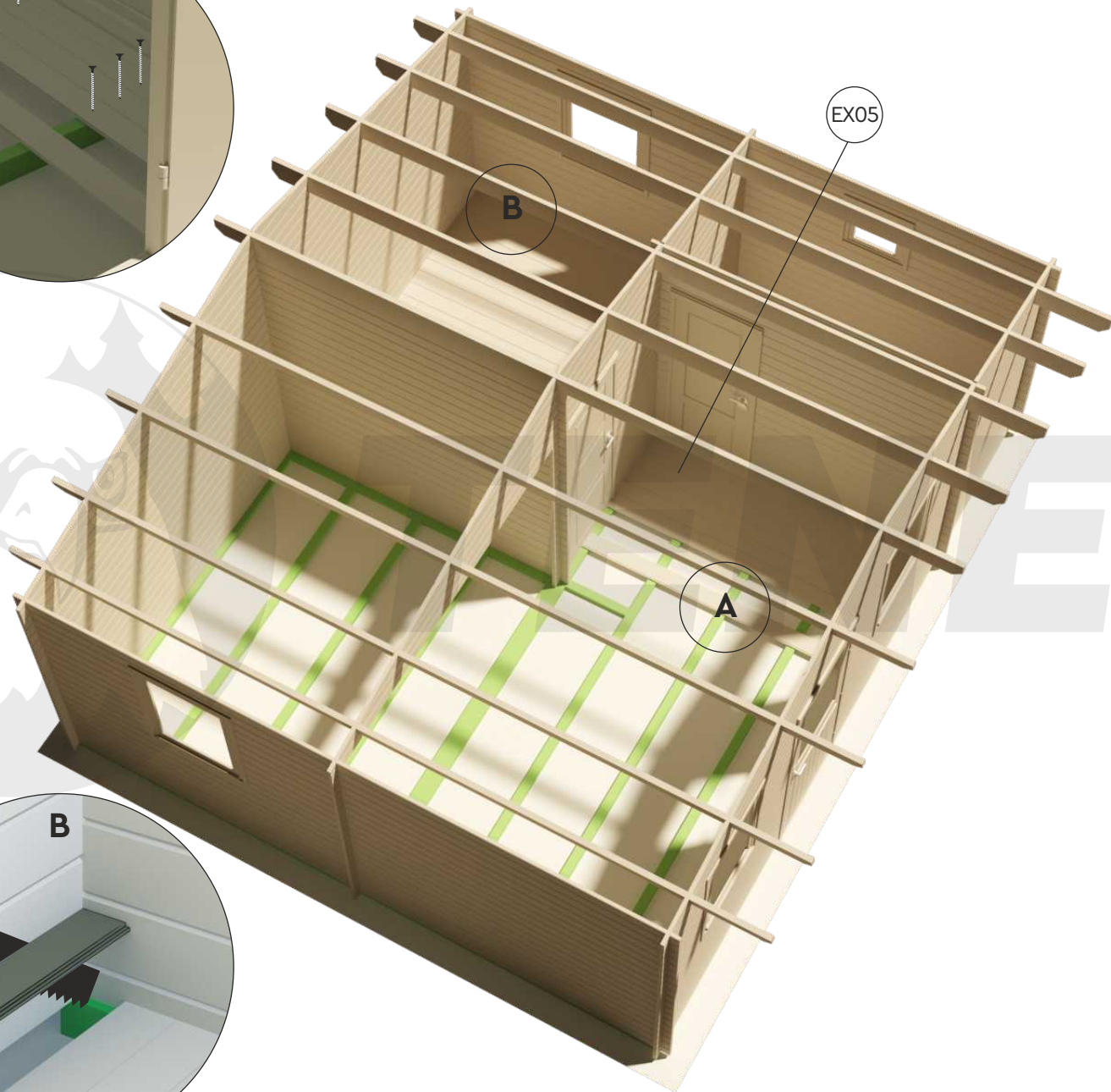
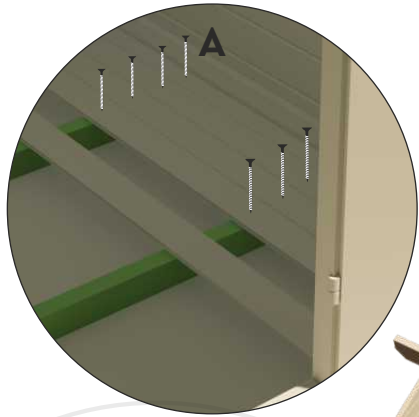

CABRIEL A 28

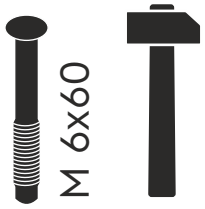
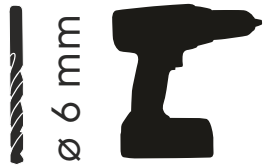
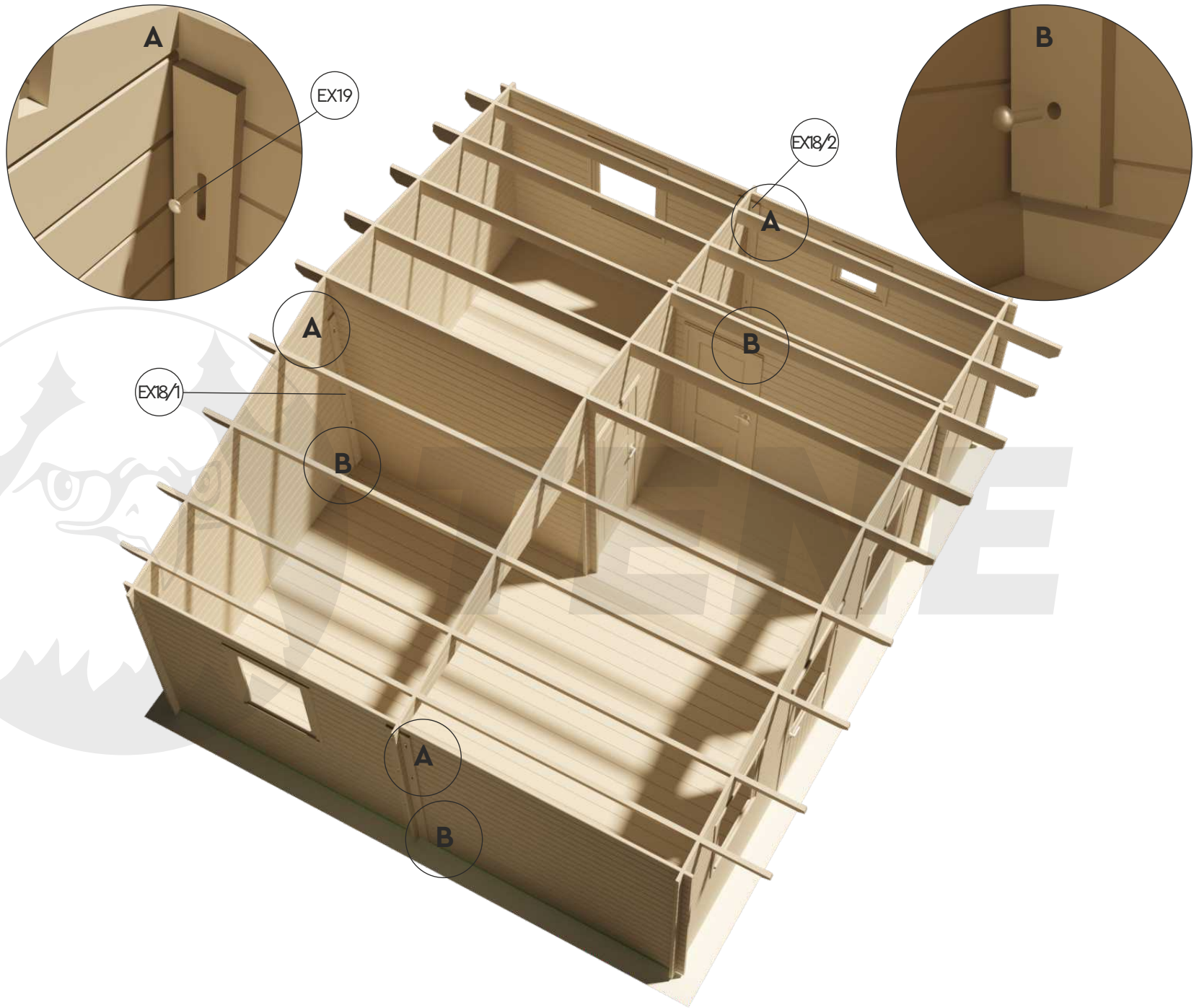

CABRIEL A 28

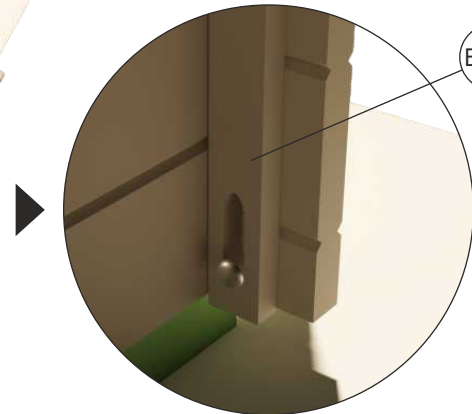
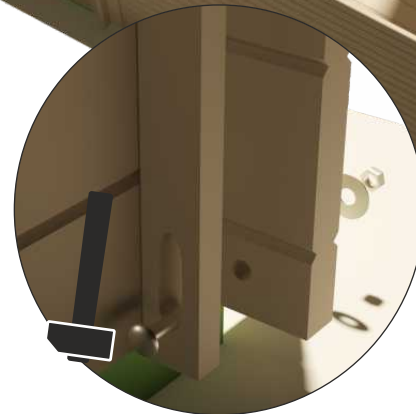
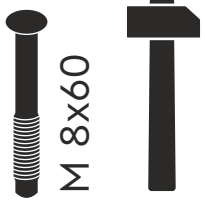
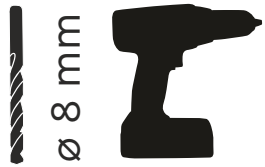
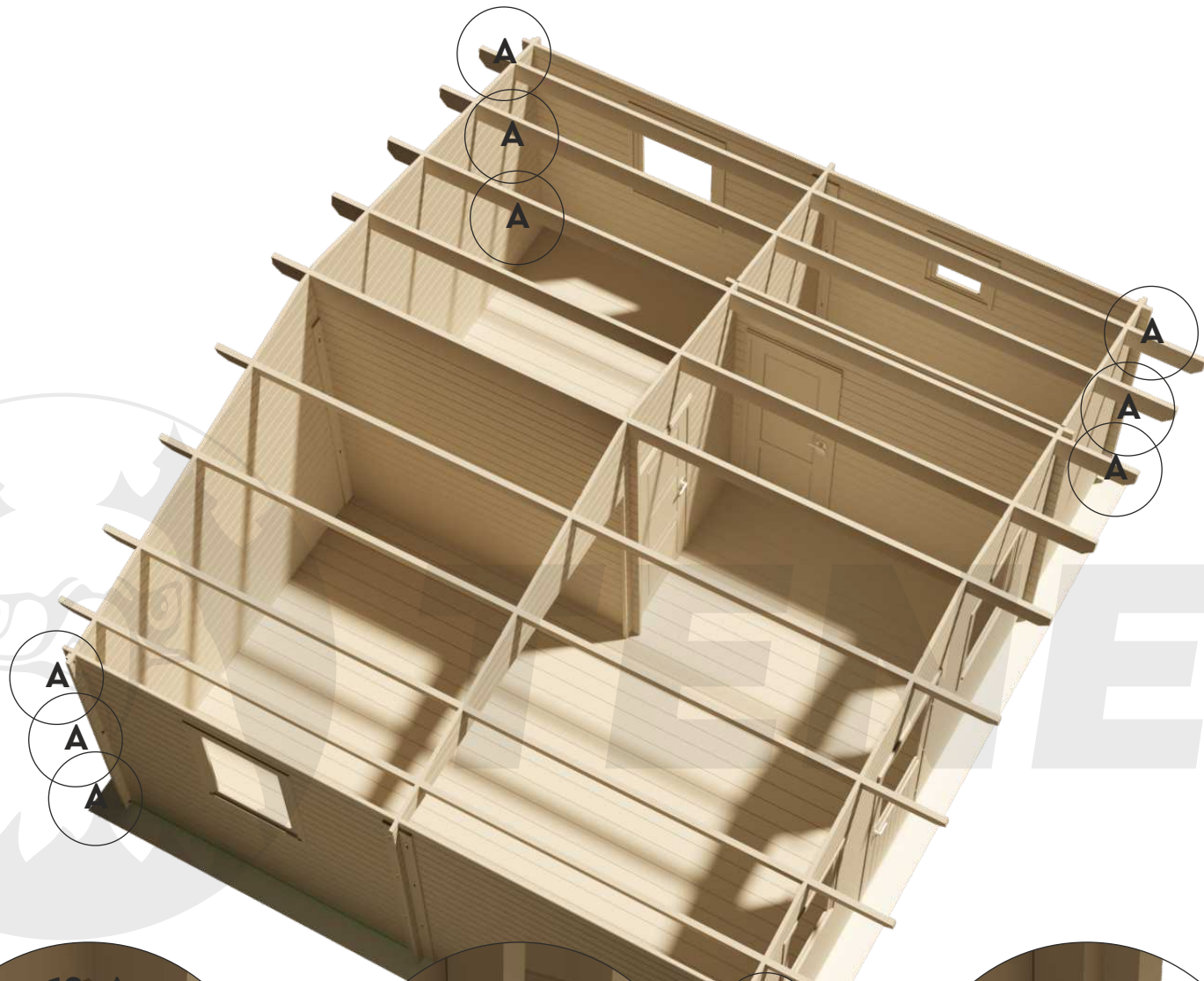

CABRIEL A 28

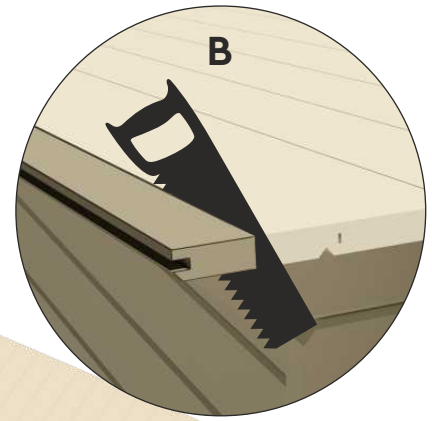
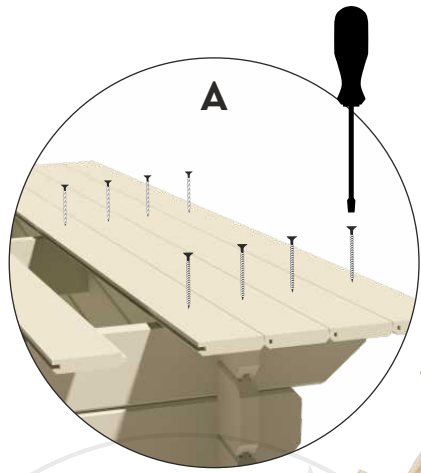
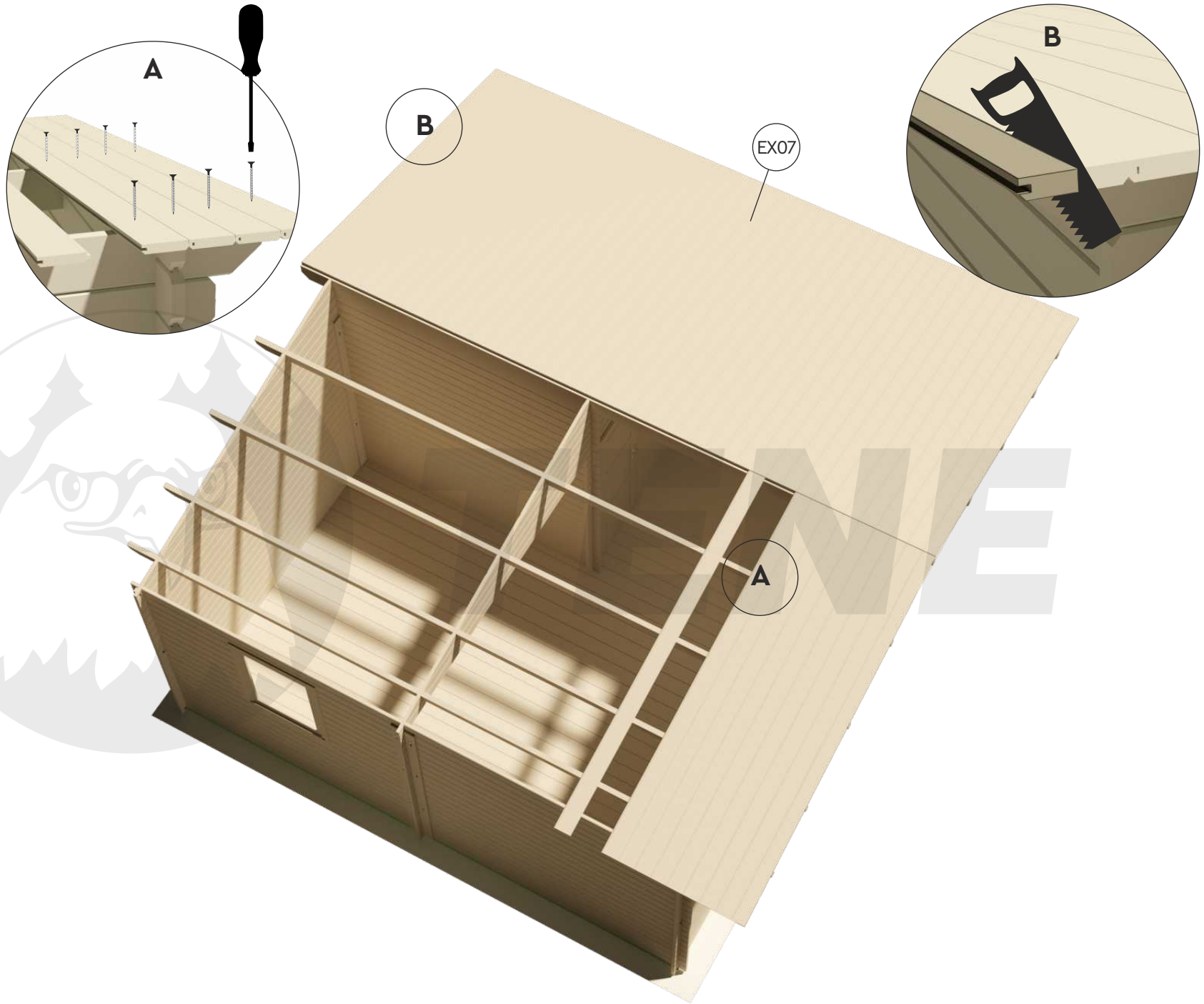

CABRIEL A 28

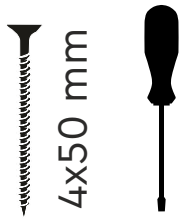
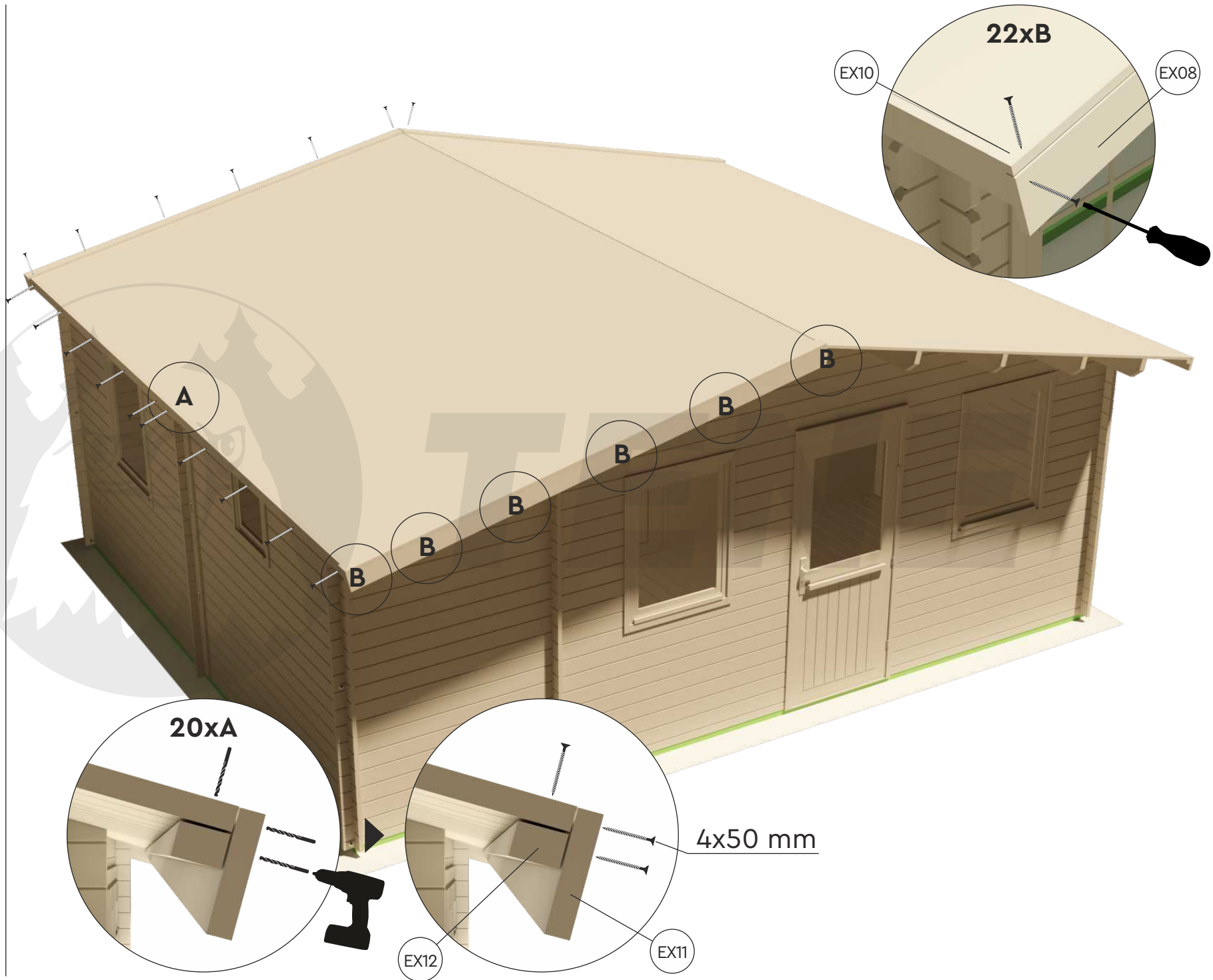

CABRIEL A 28

