

# NAVIA 28

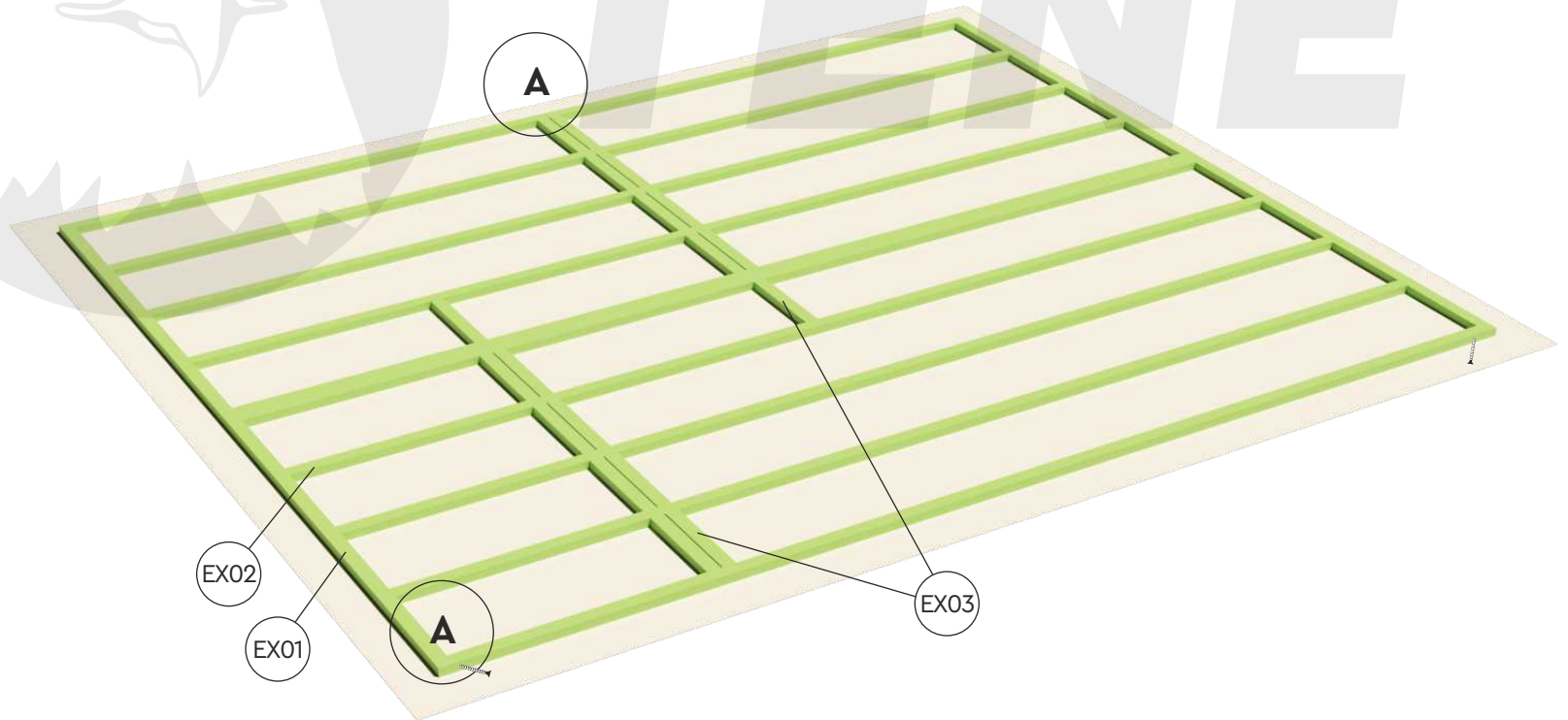

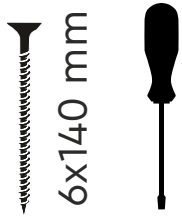

# NAVIA 28

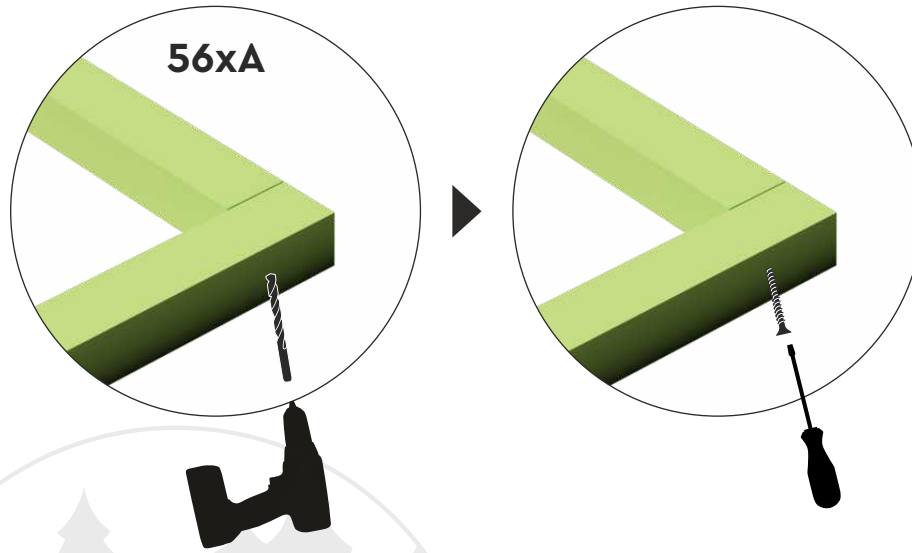
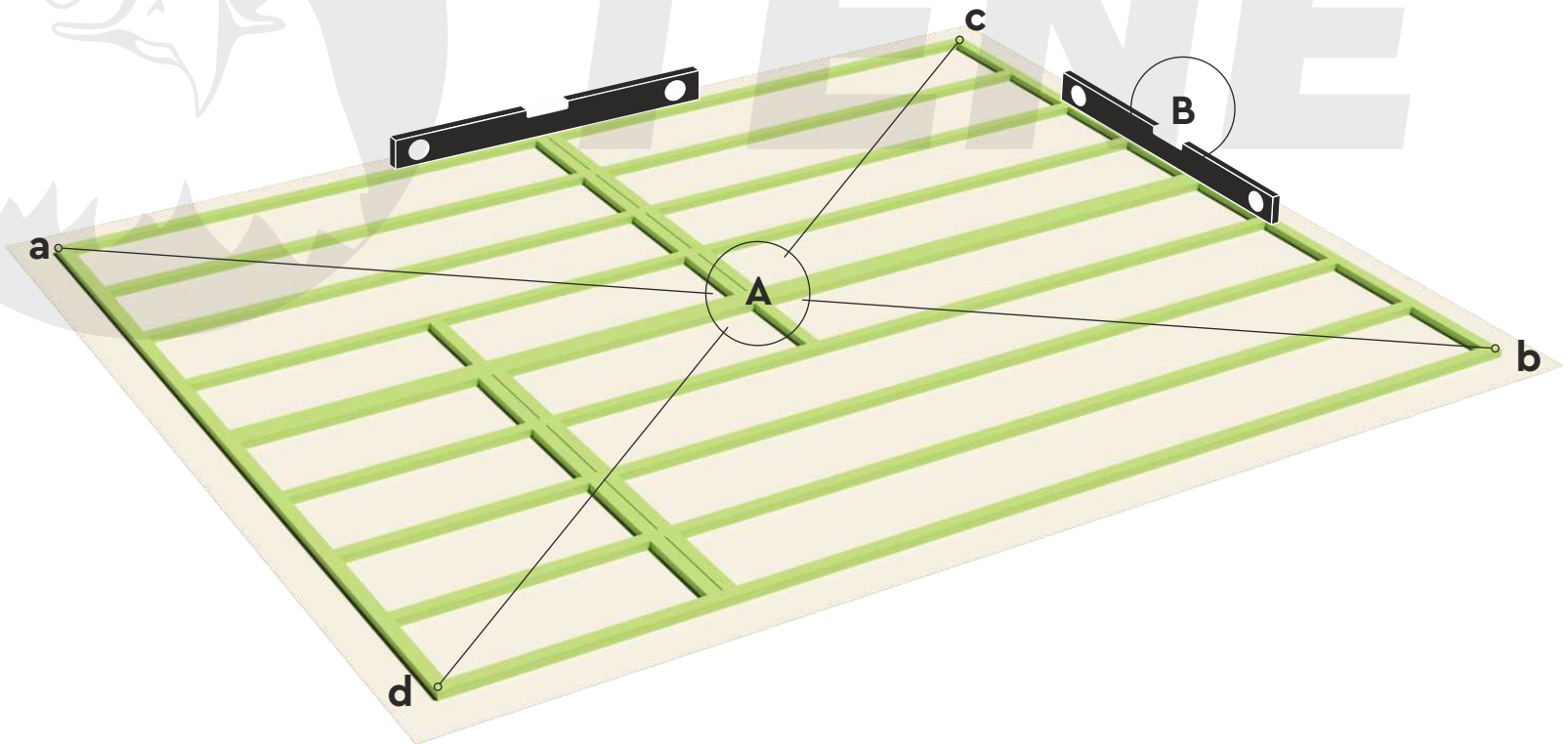
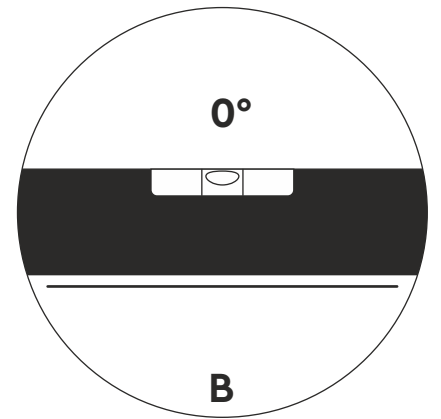
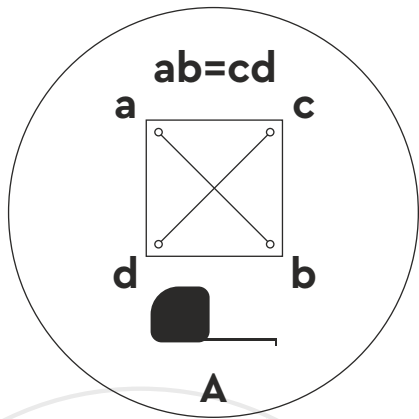
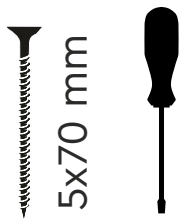
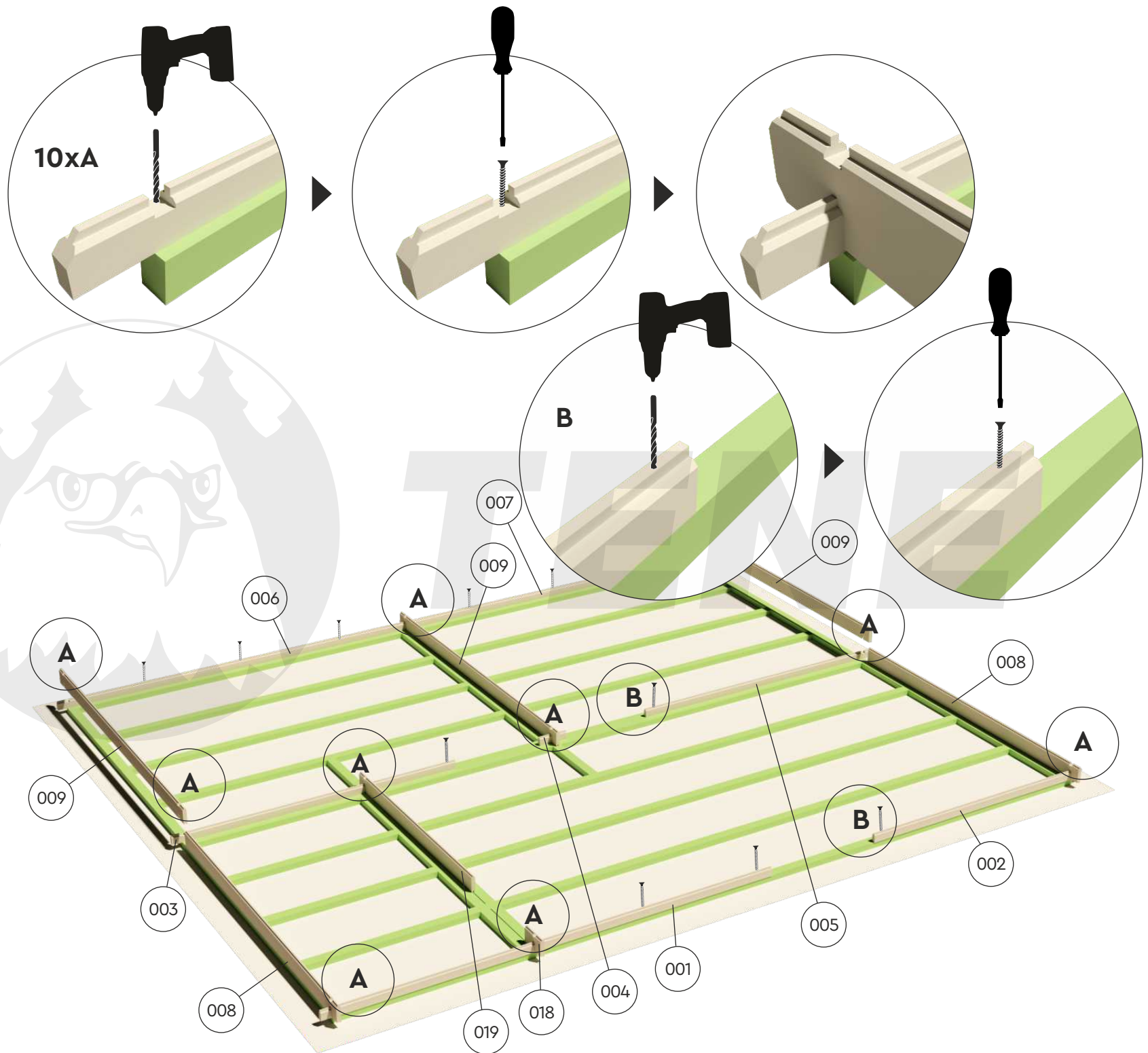

# NAVIA 28

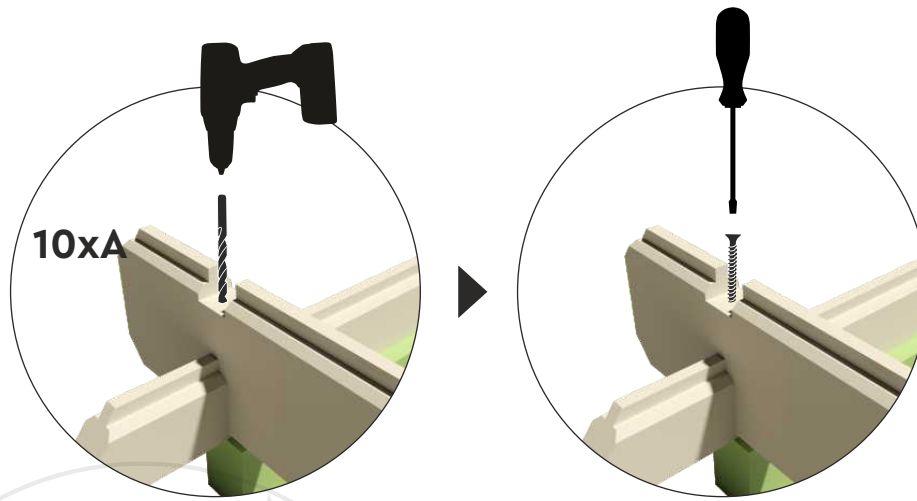

Ø 5 mm

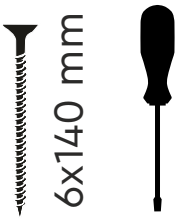

6x140 mm

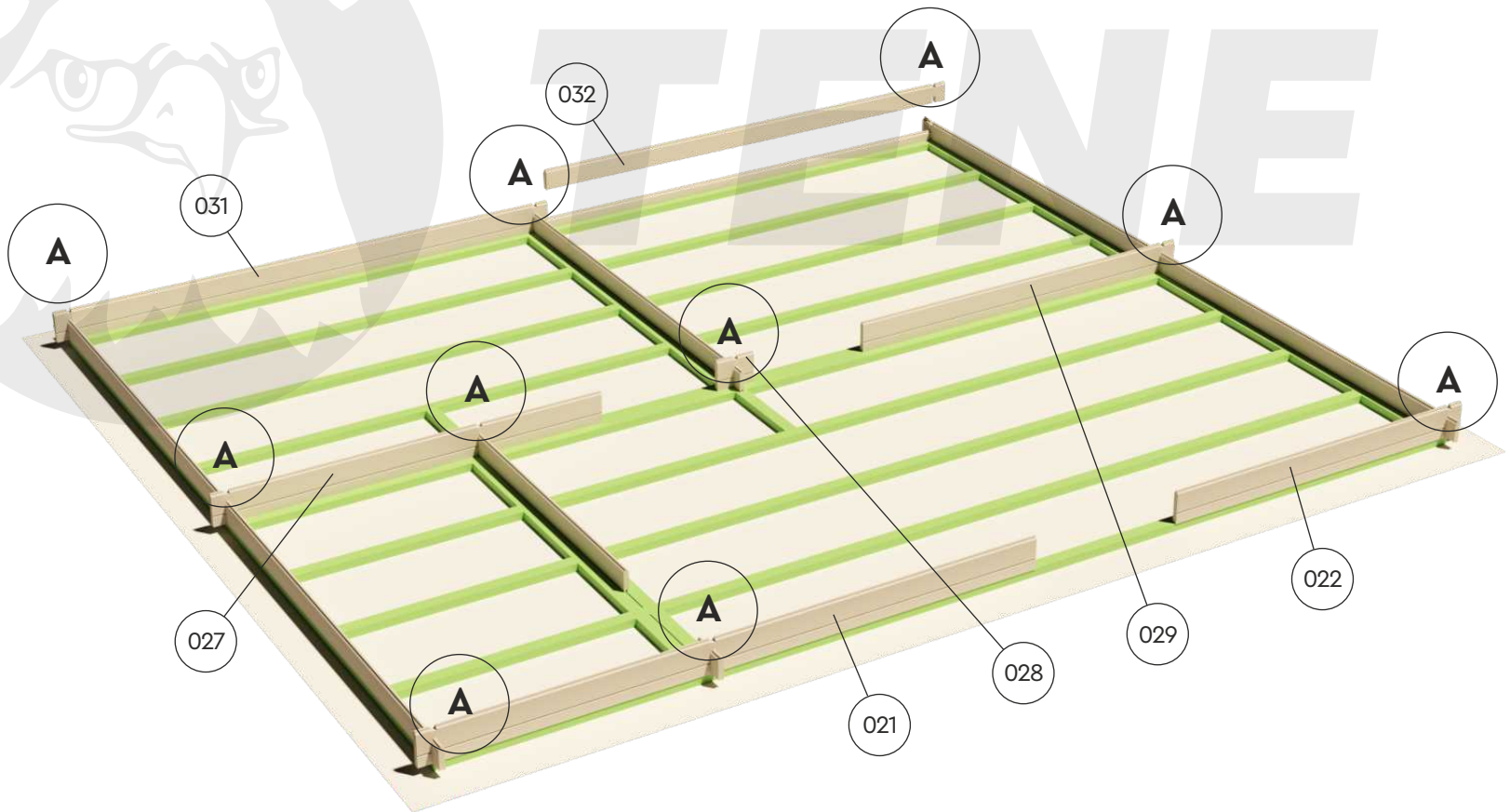

# NAVIA 28

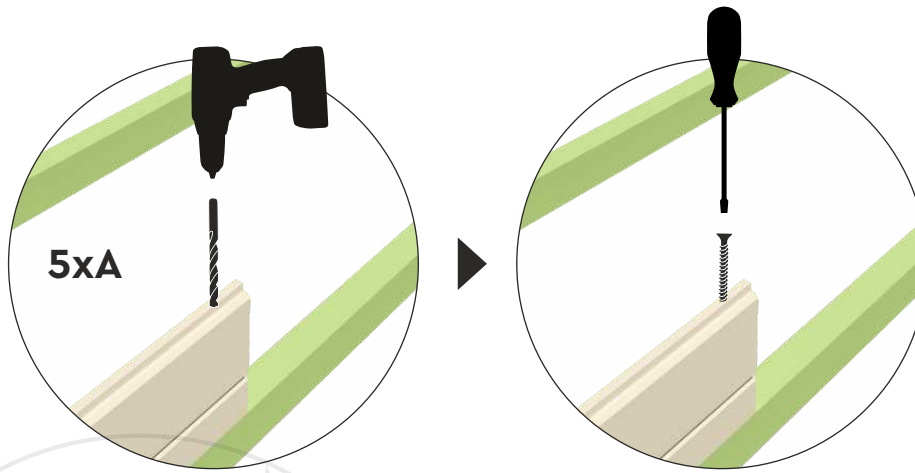

Ø 5 mm

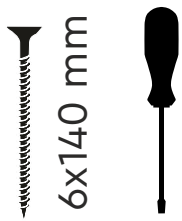

6x140 mm

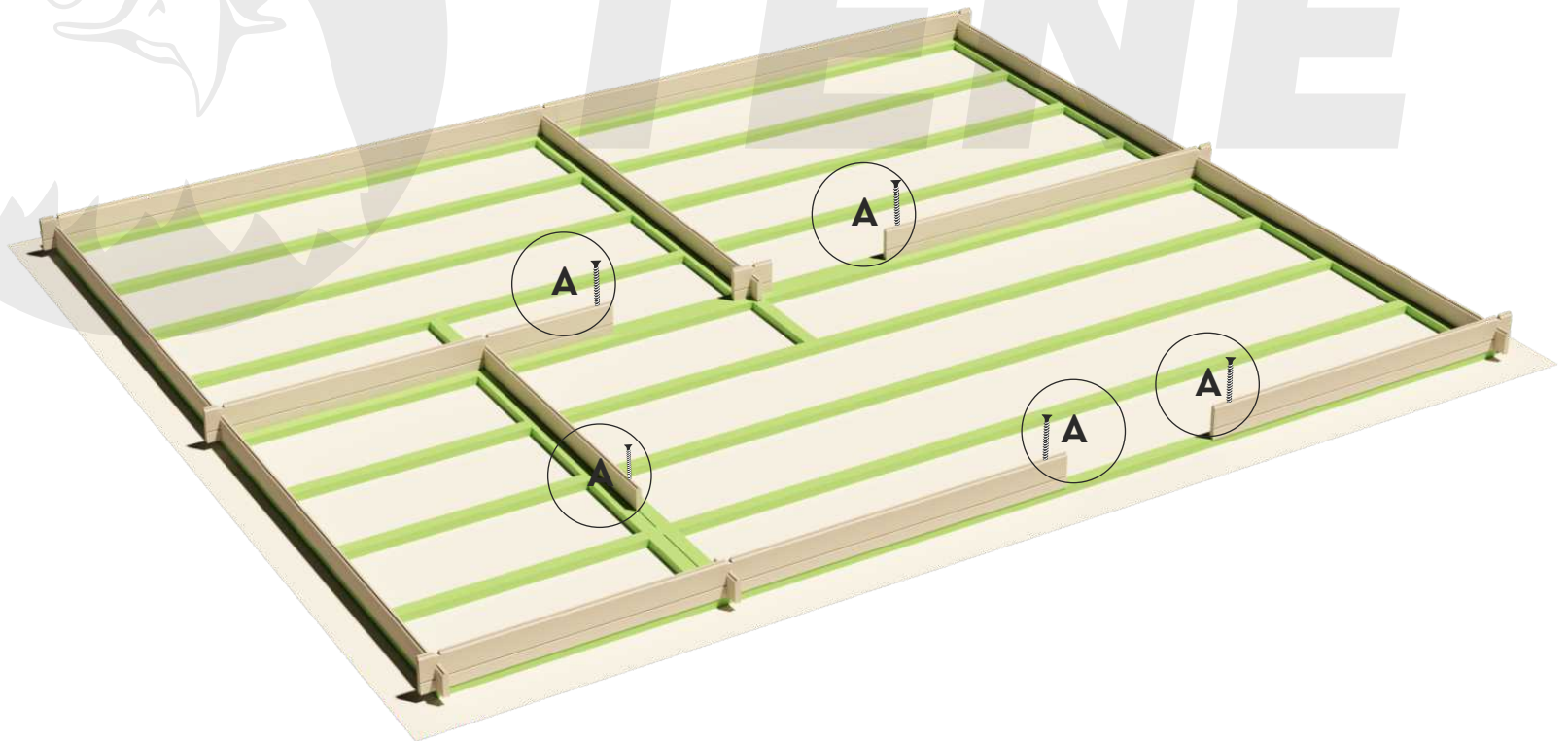

# NAVIA 28

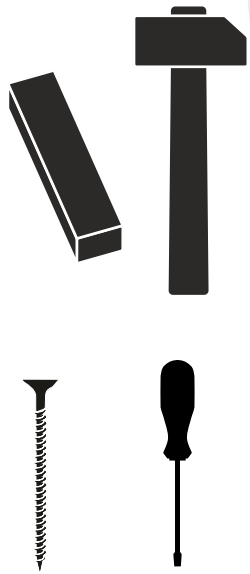
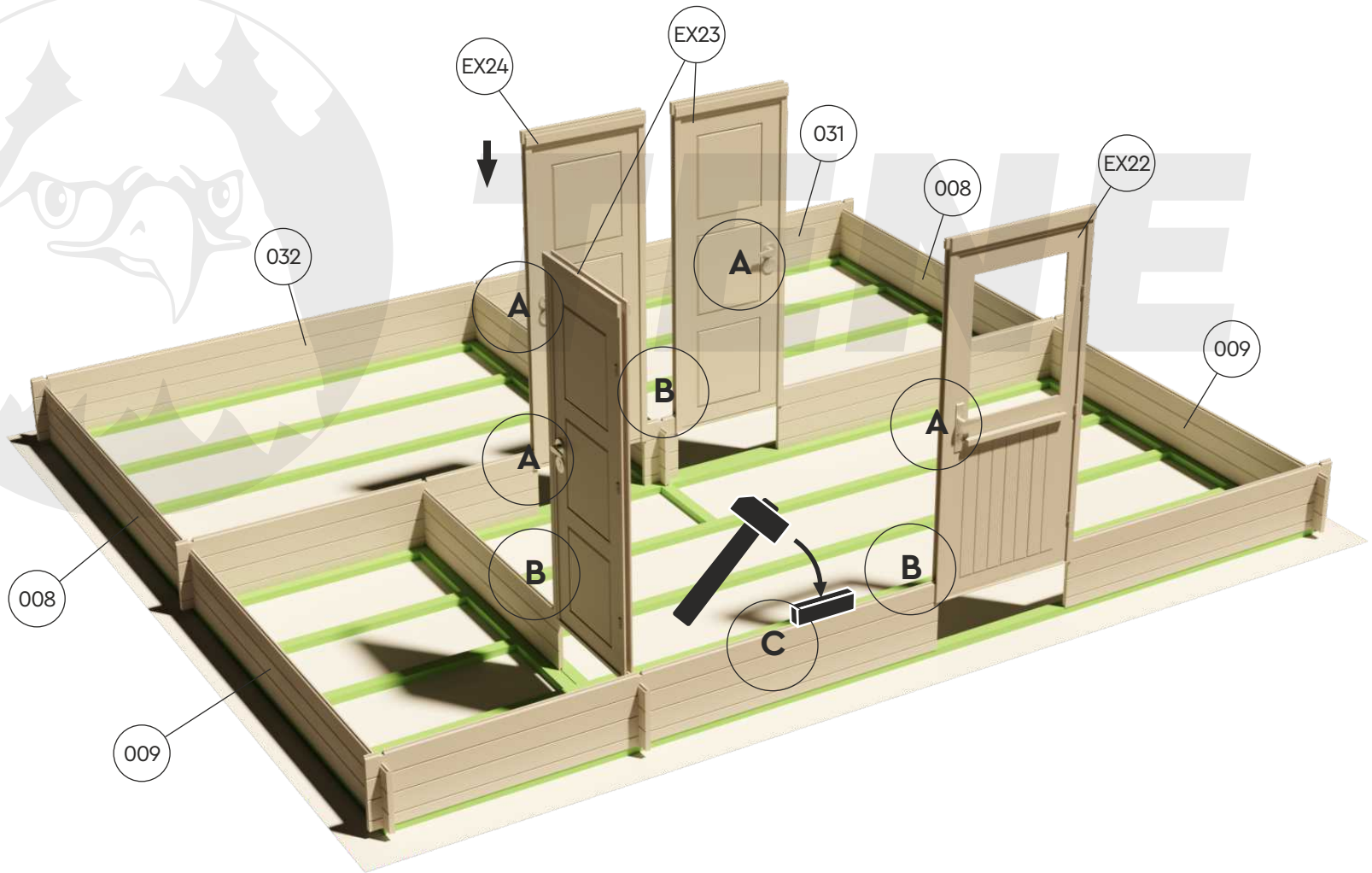
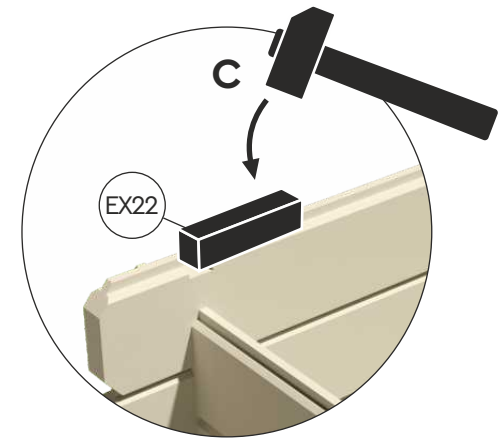
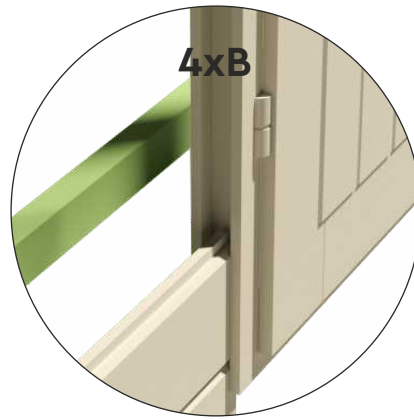
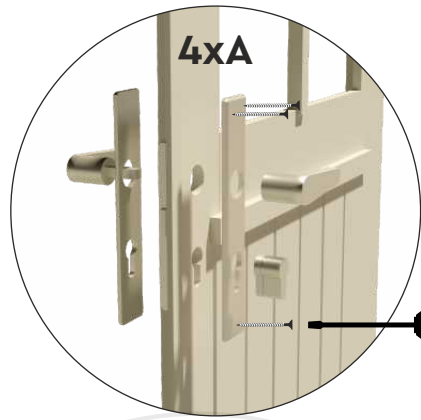

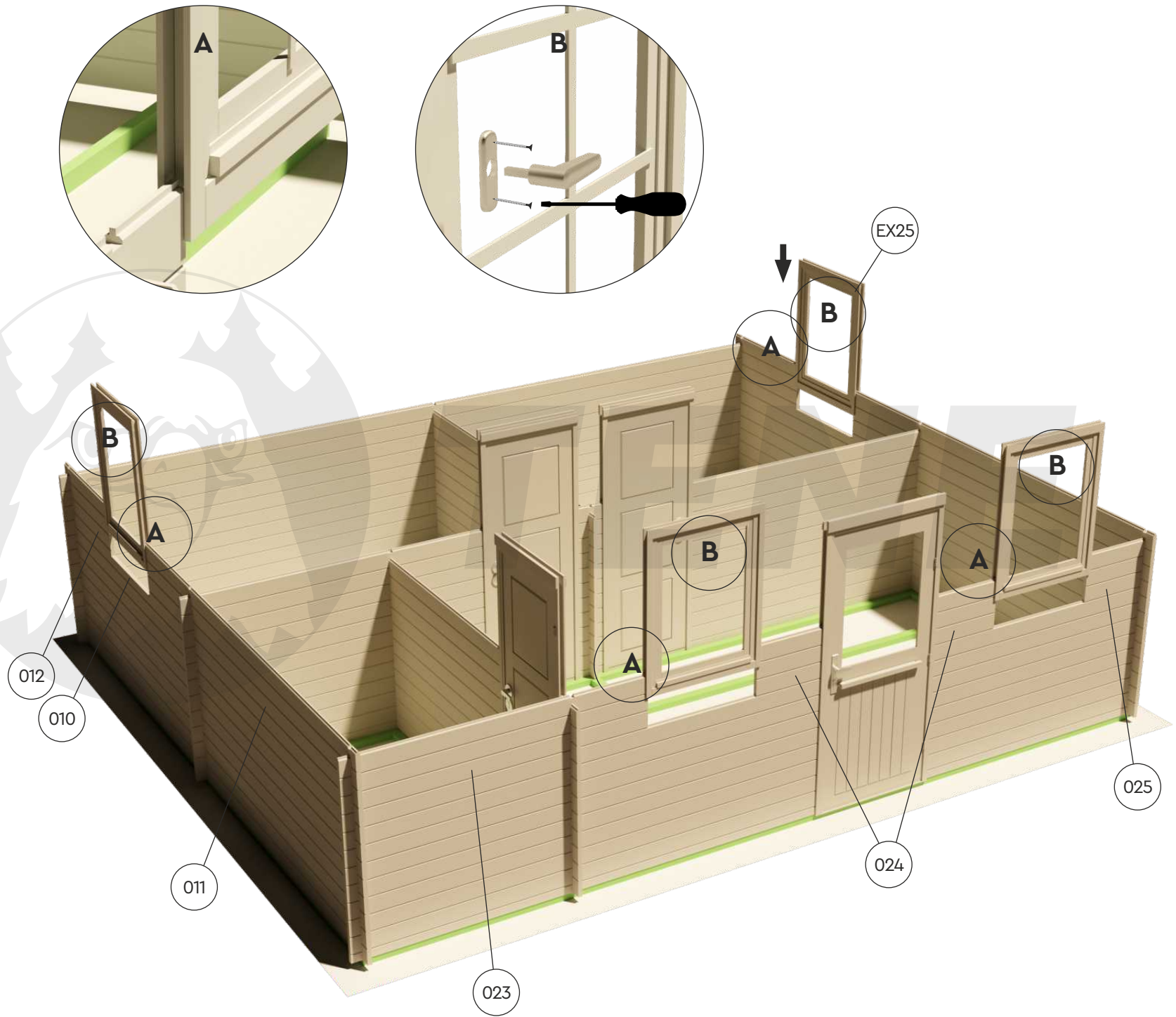



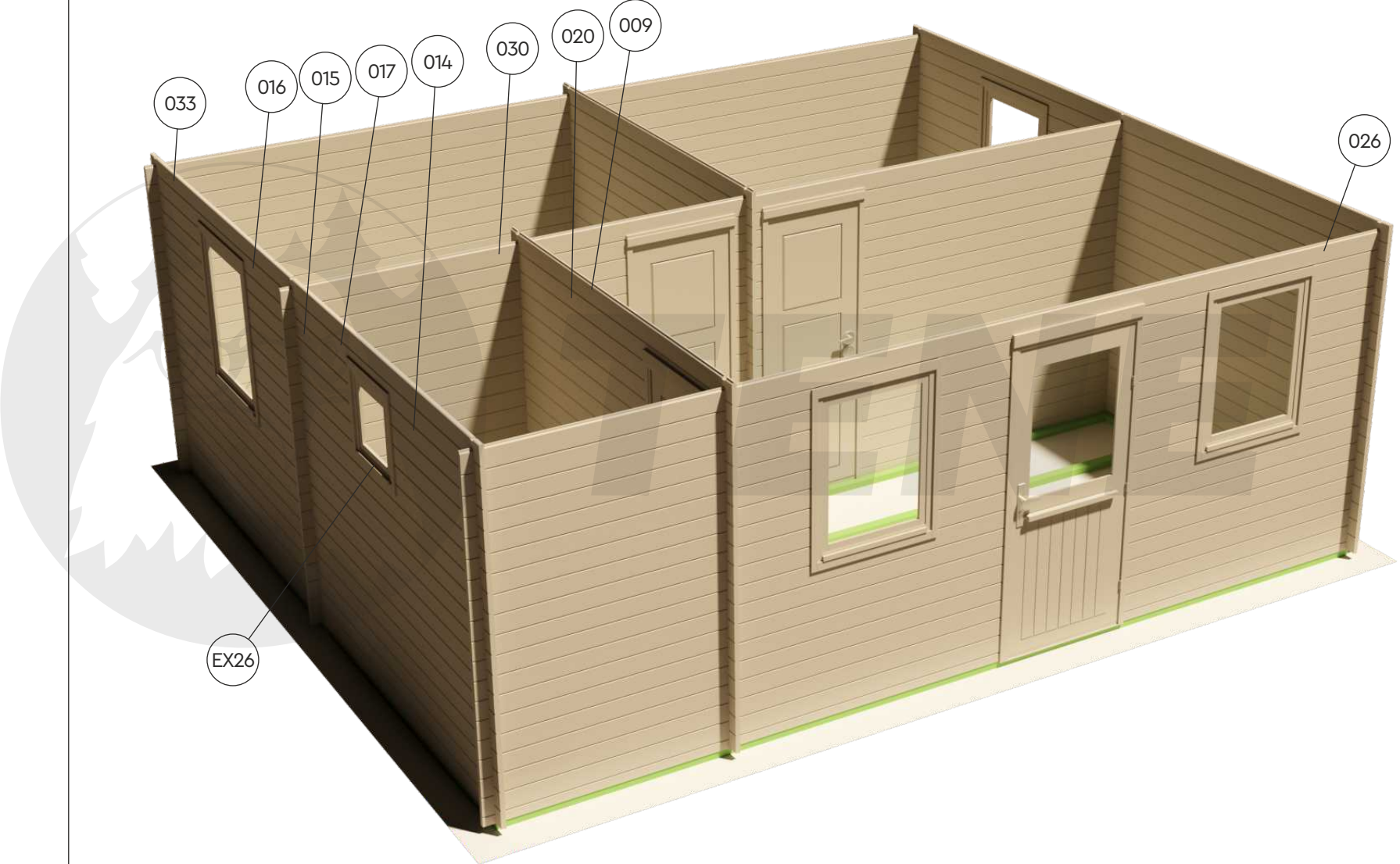

# NAVIA 28

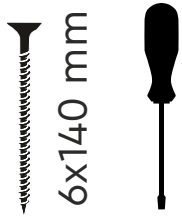
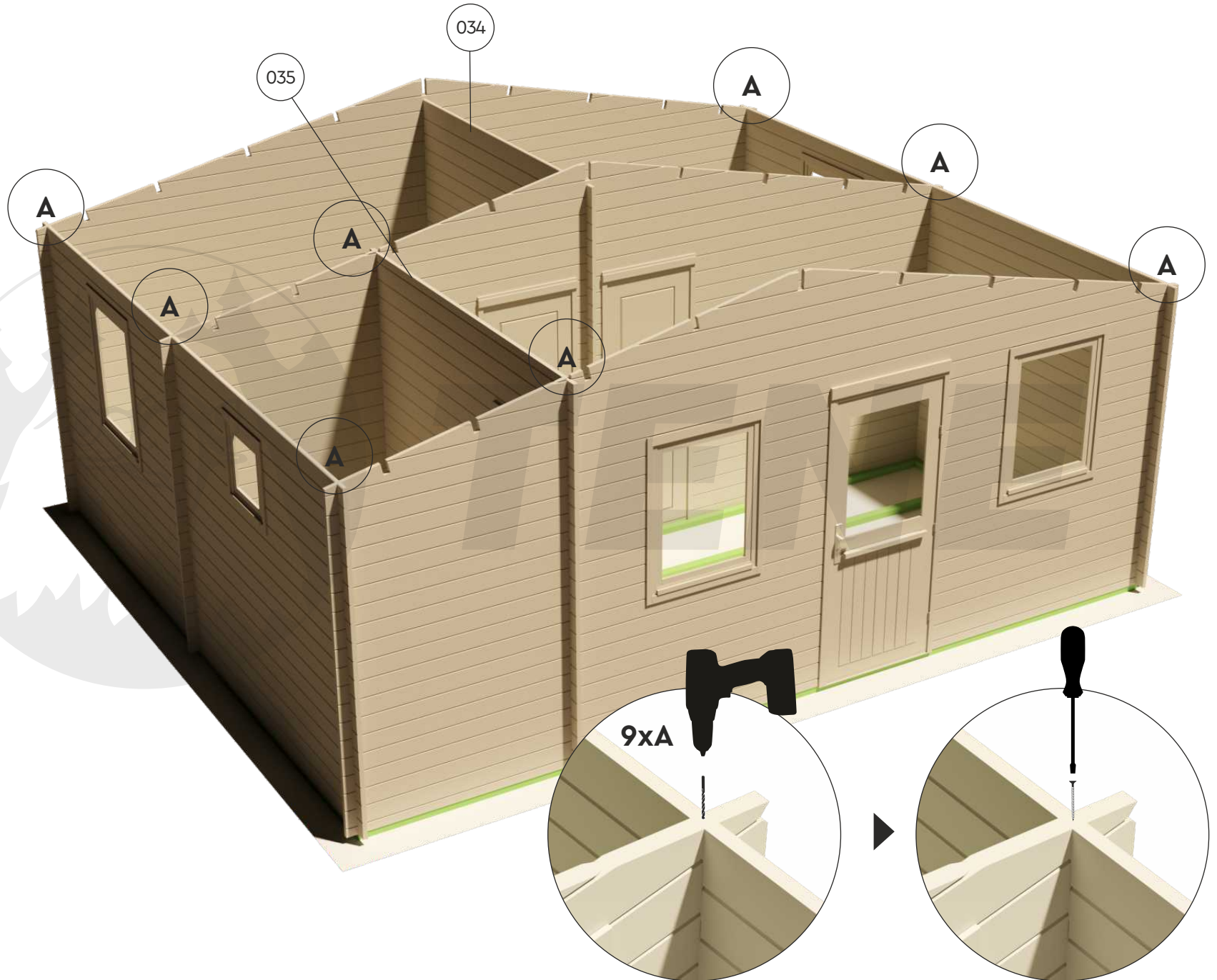

# NAVIA 28

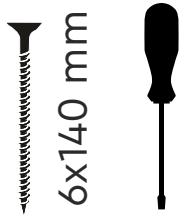
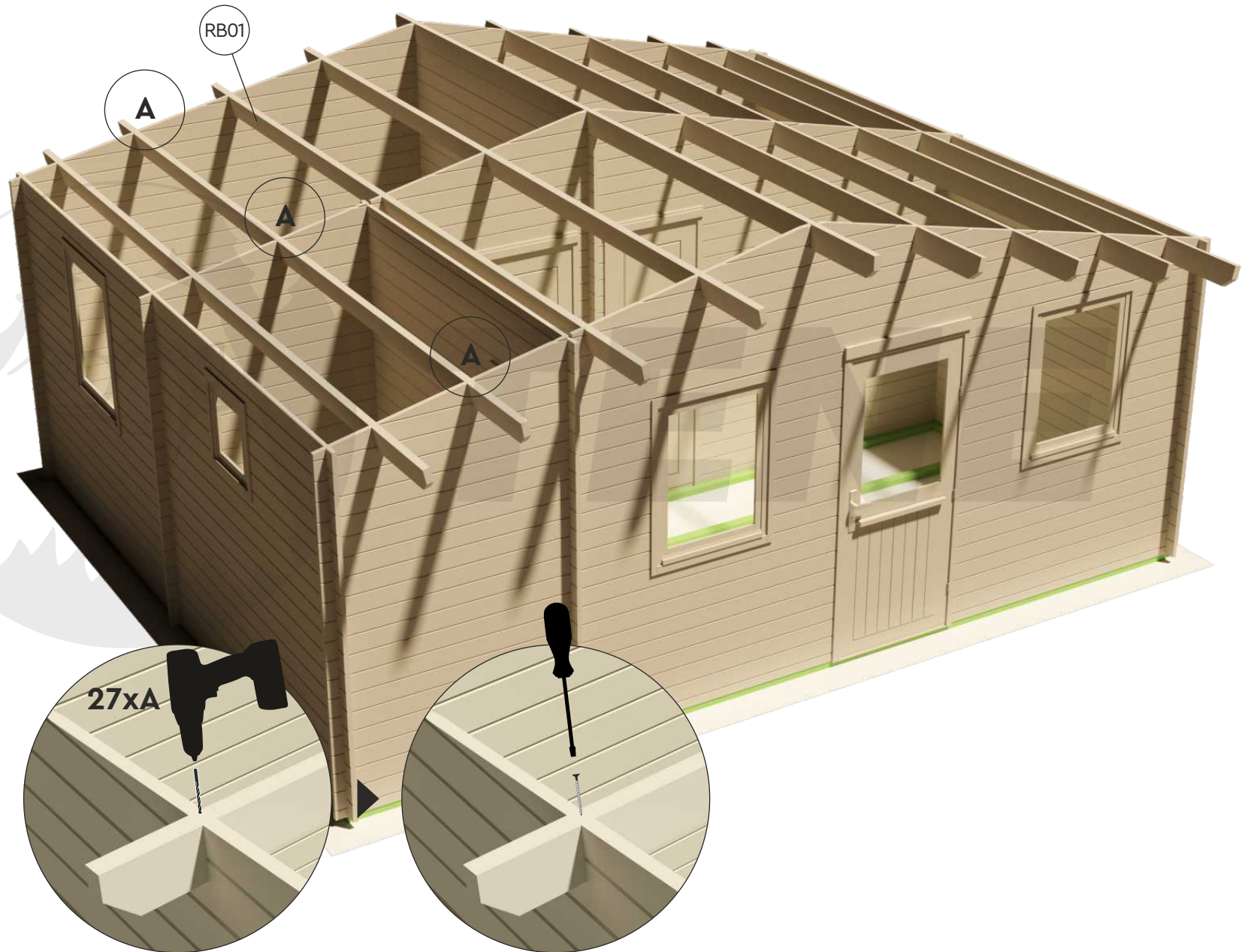

# NAVIA 28

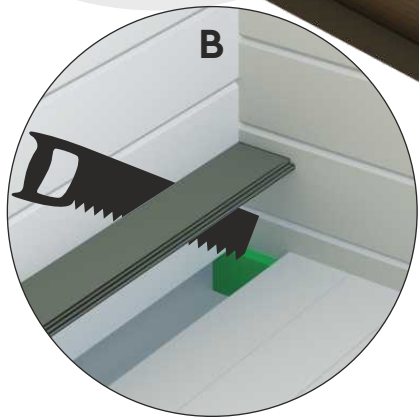
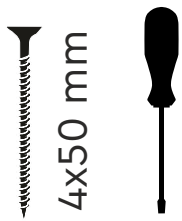
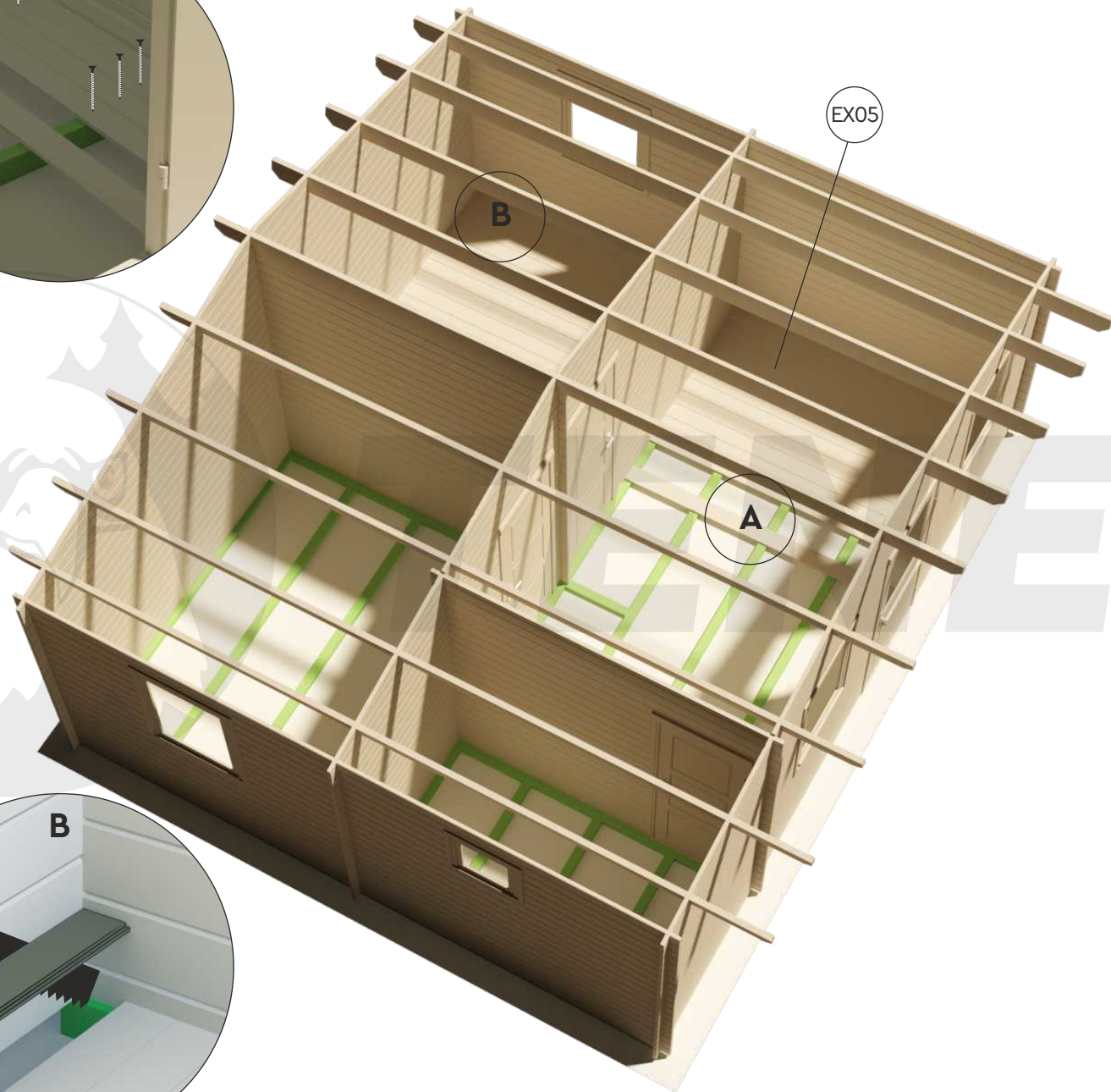
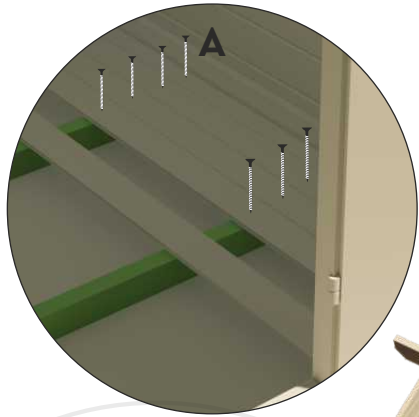

# NAVIA 28

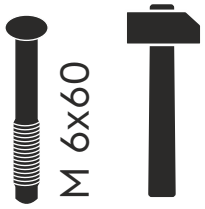
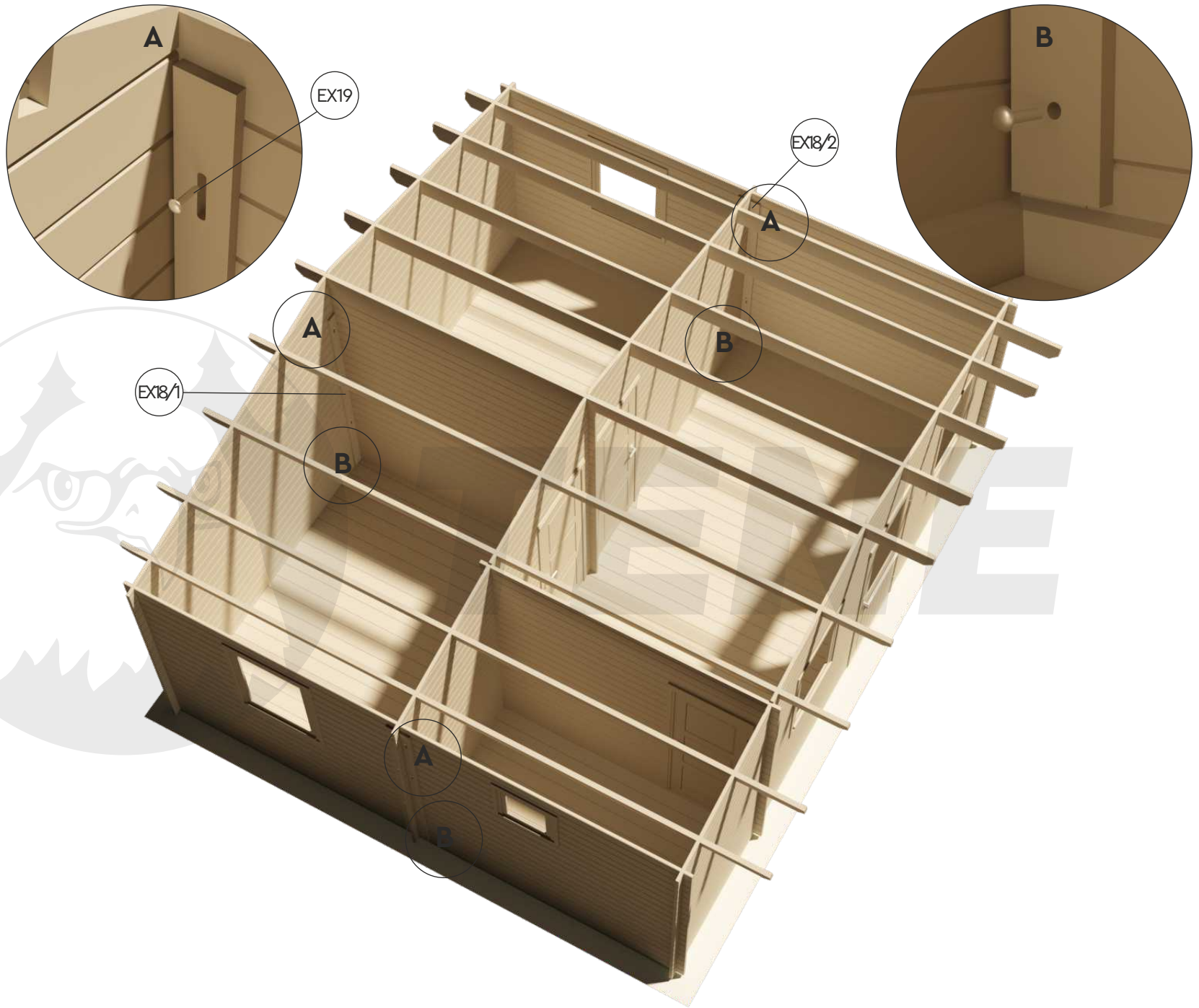

# NAVIA 28

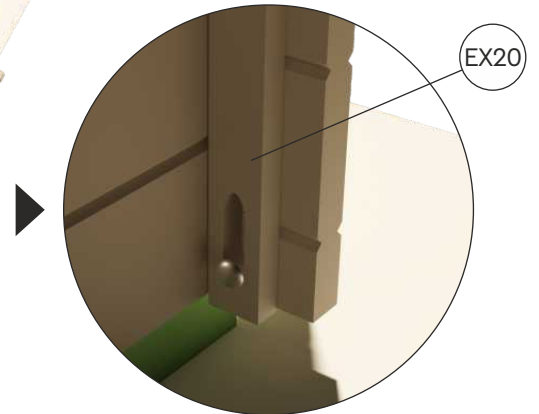
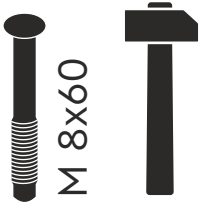
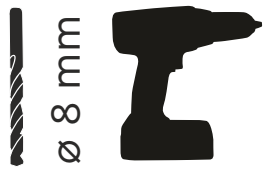
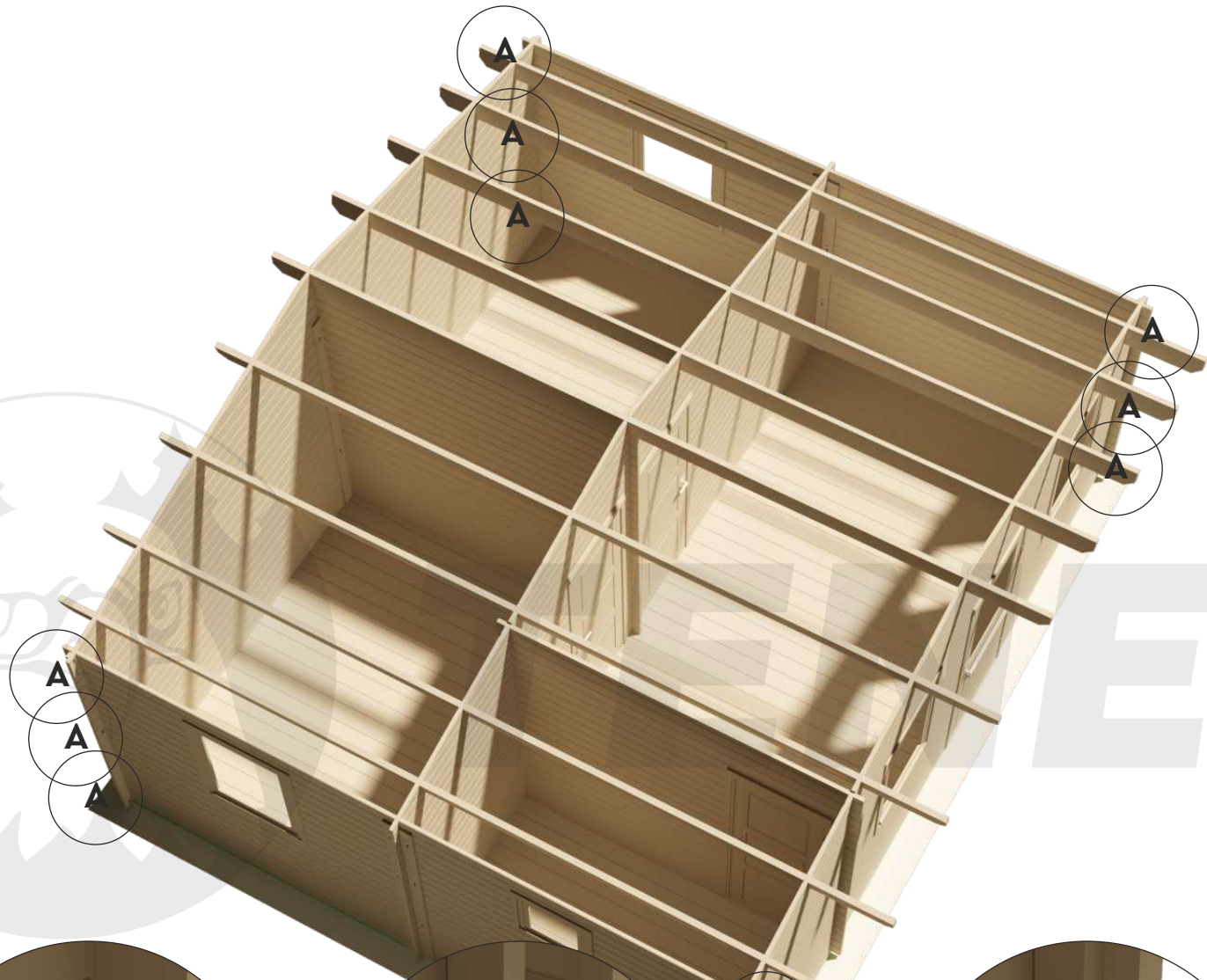

# NAVIA 28

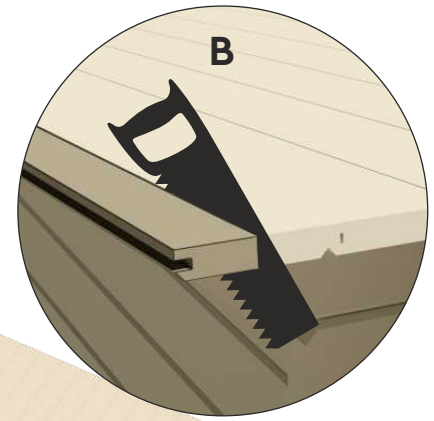
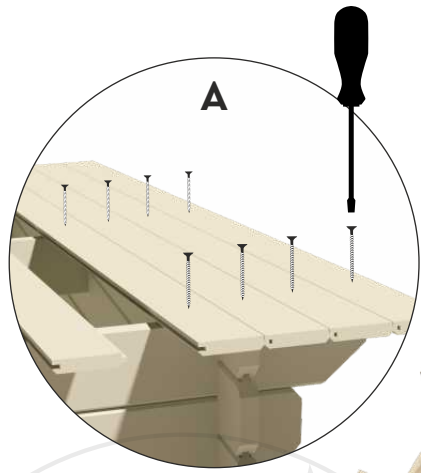
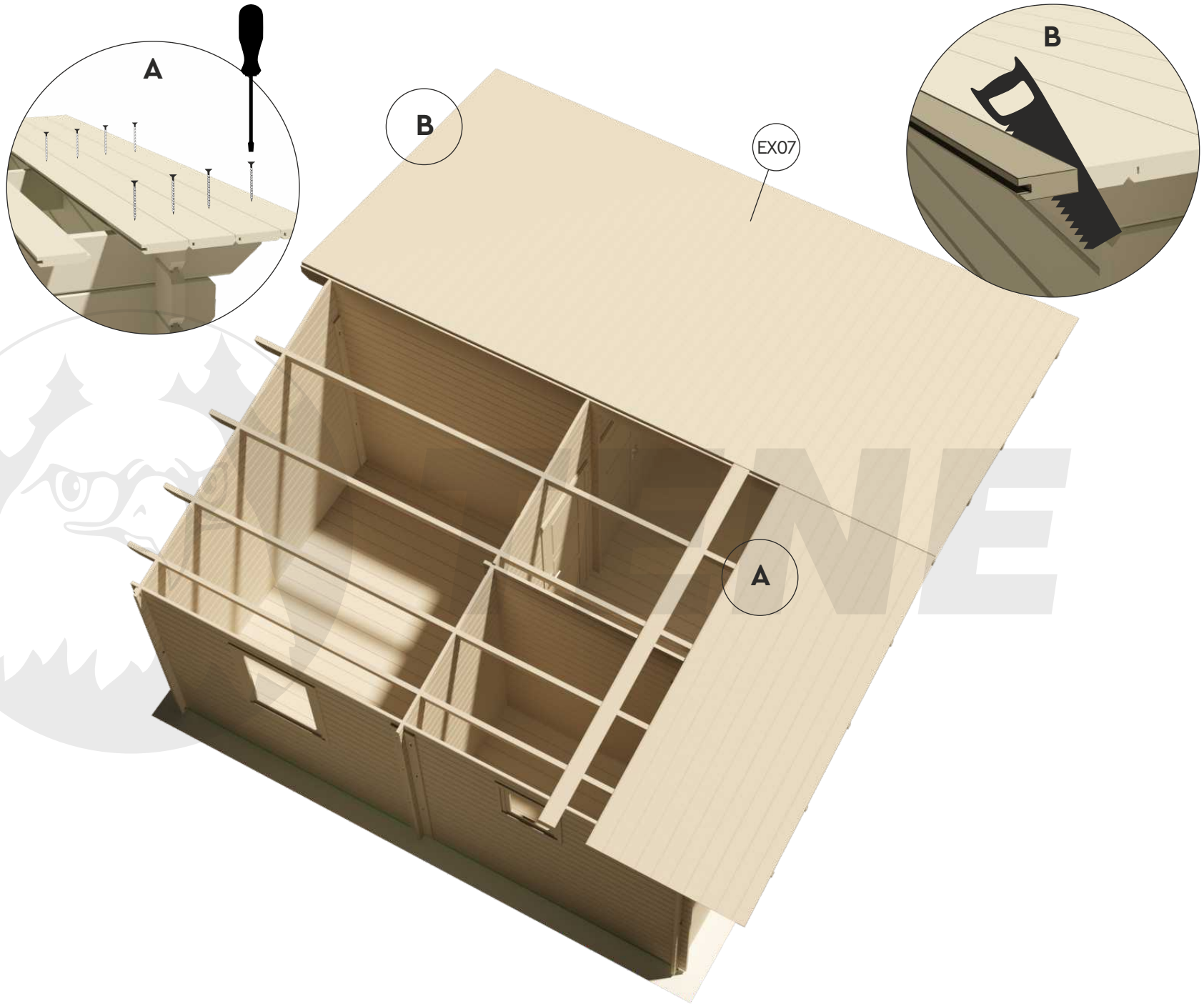

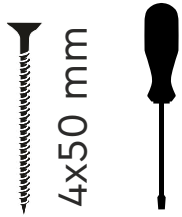
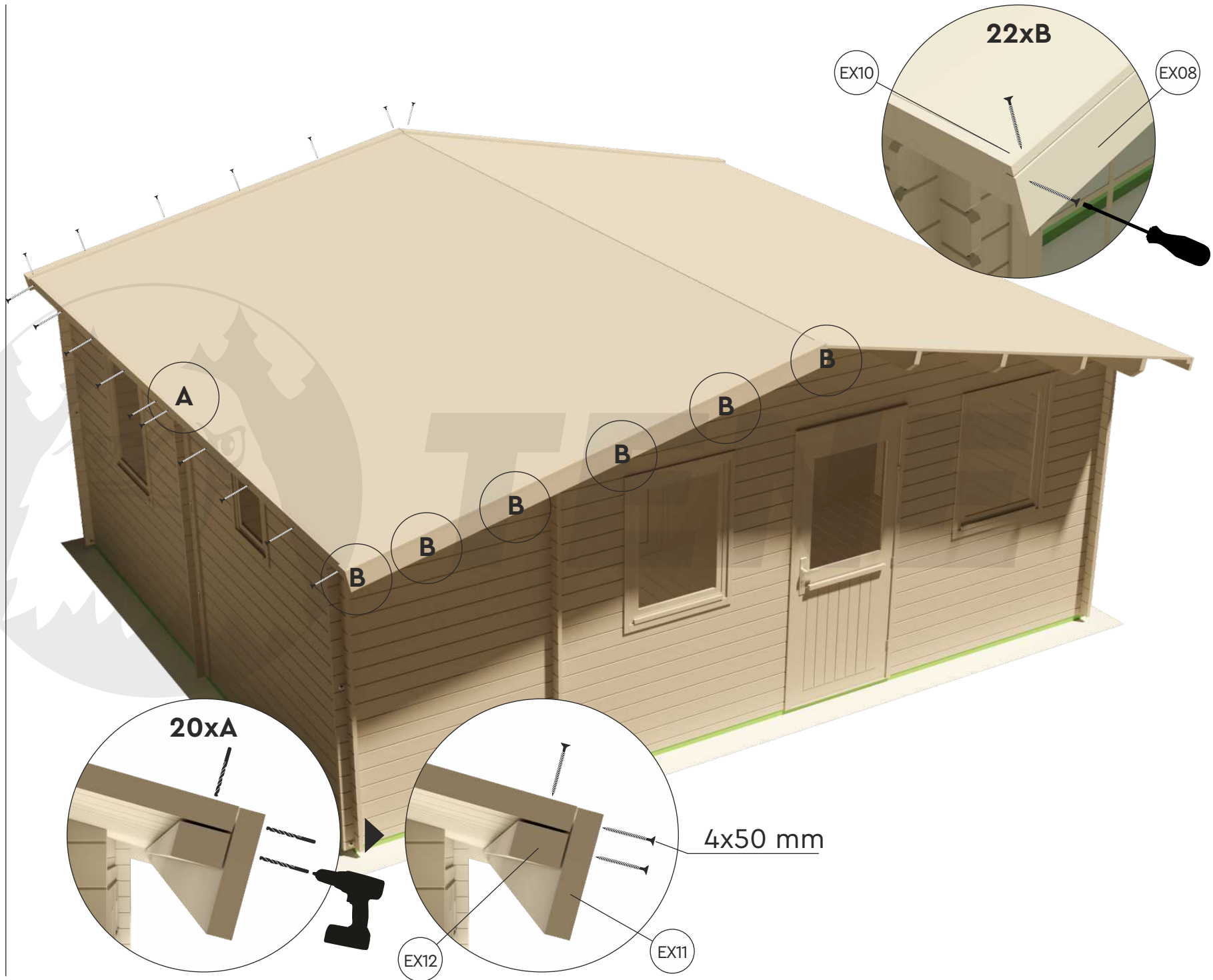



# NAVIA 28

