

VENEZIA 40

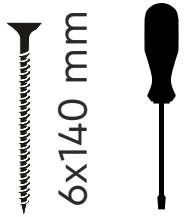

6x140 mm

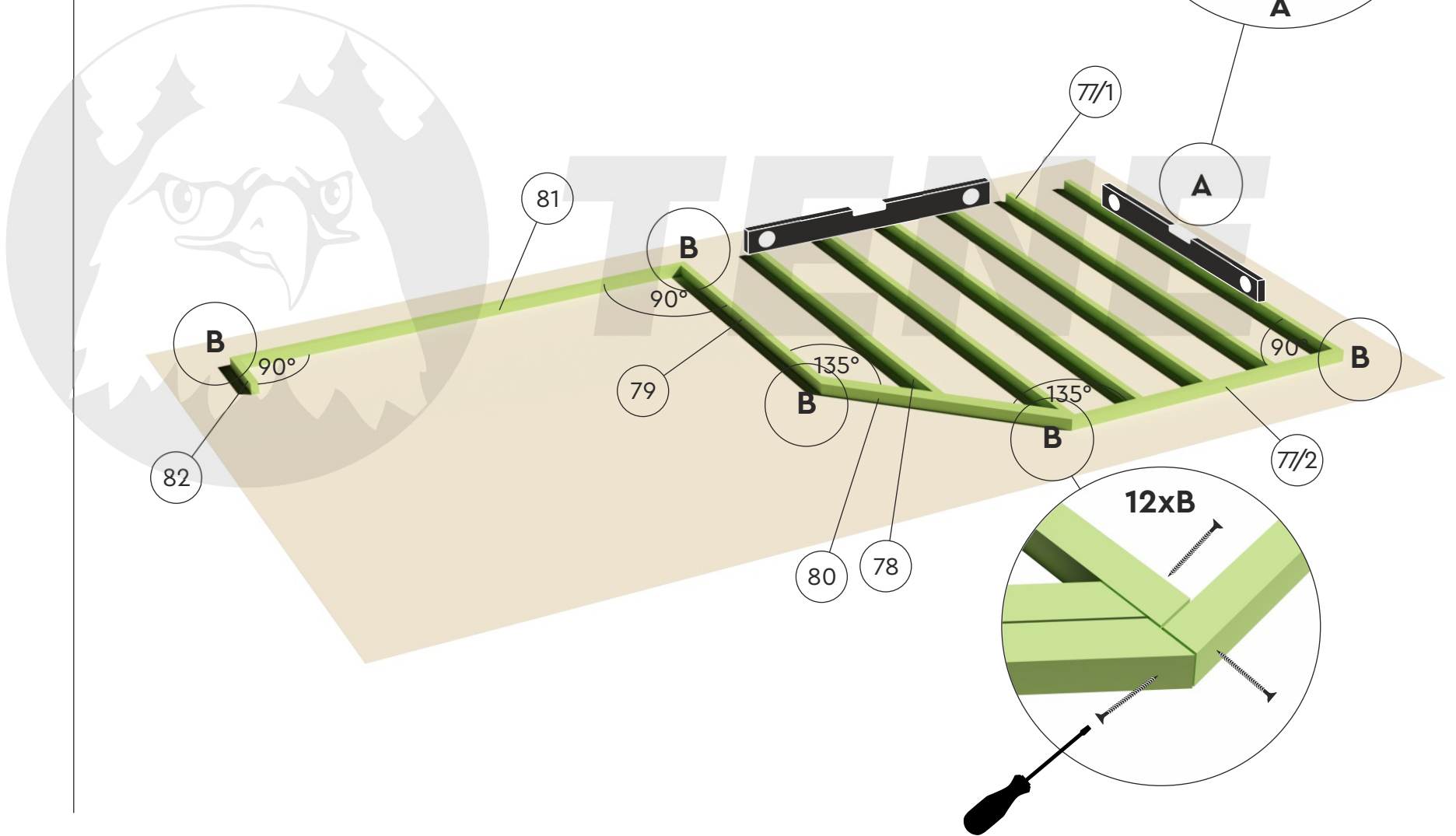

VENEZIA 40

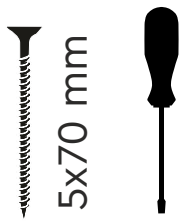
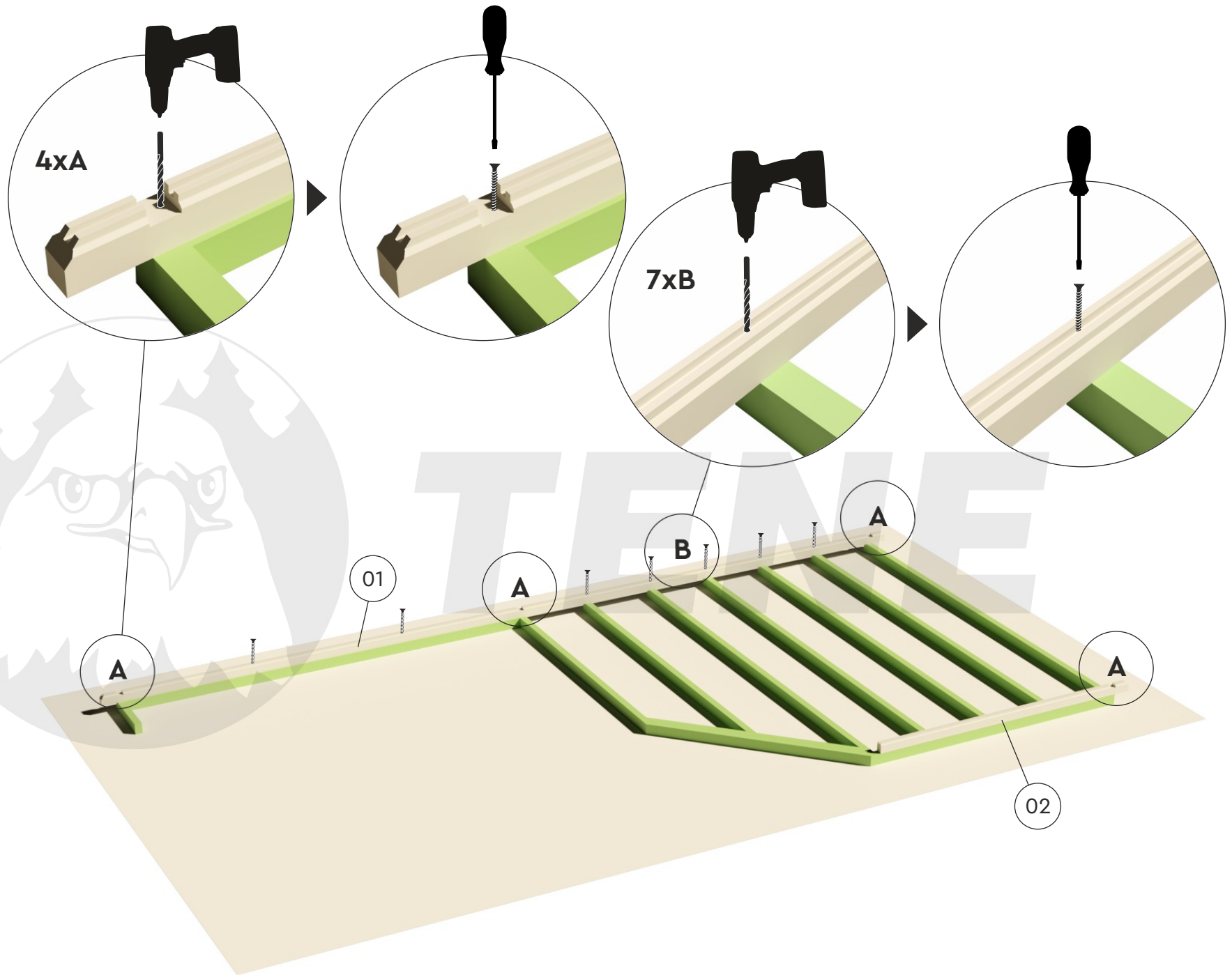

VENEZIA 40

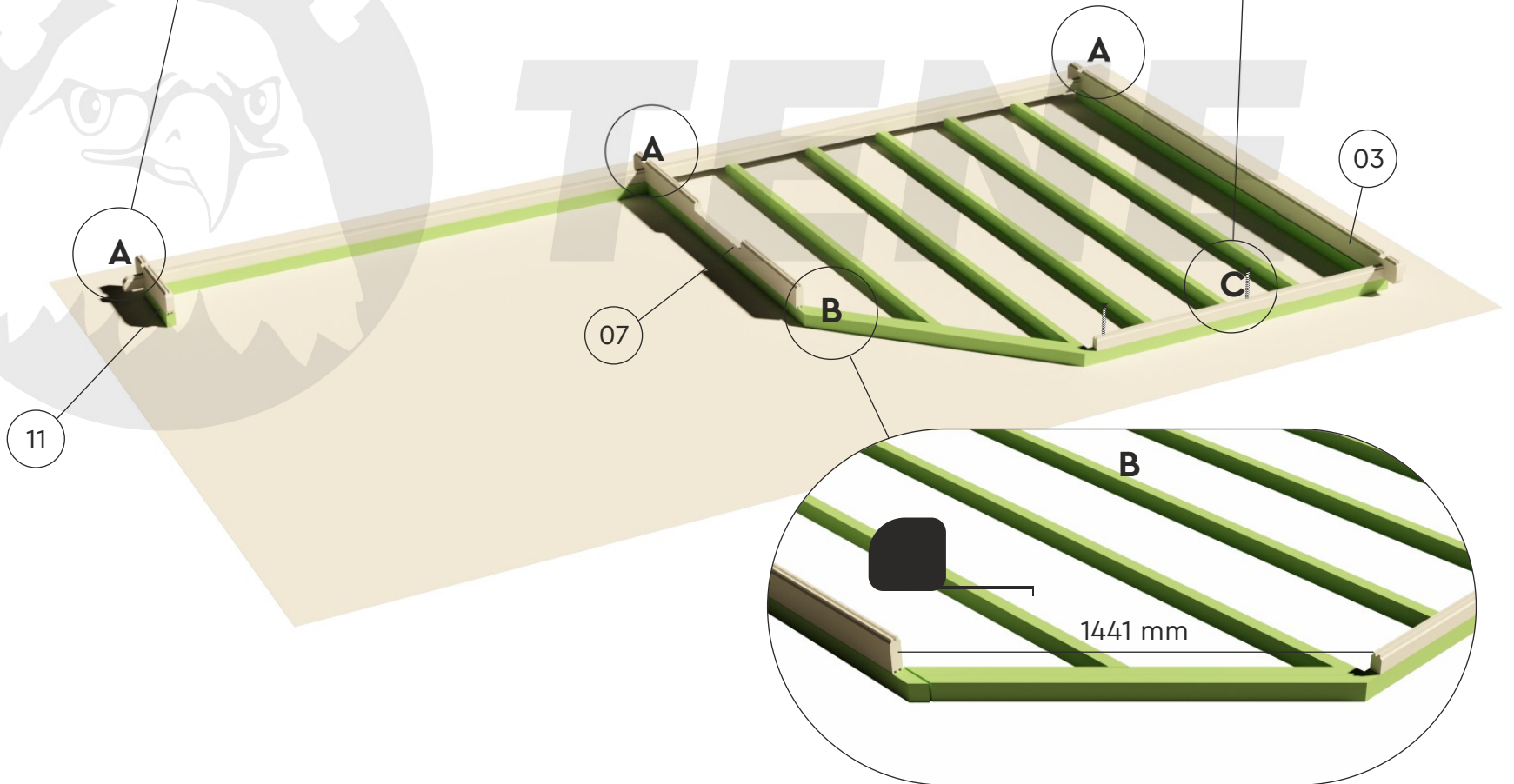
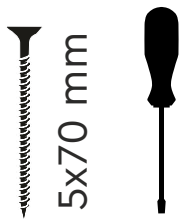
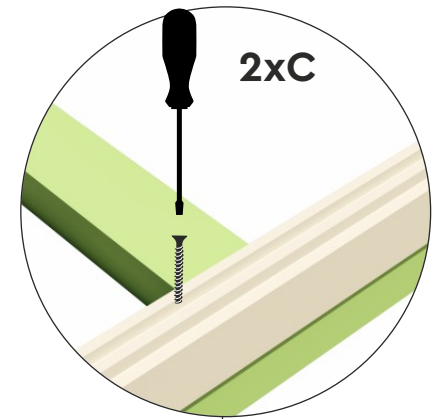
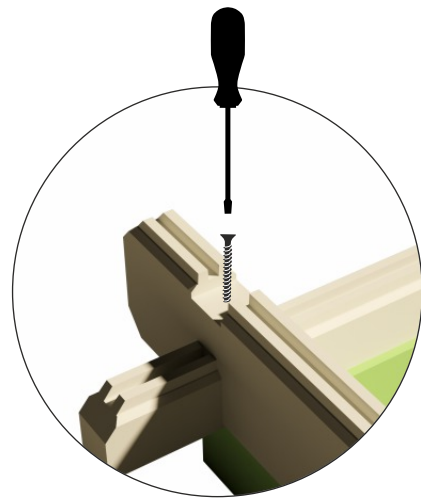
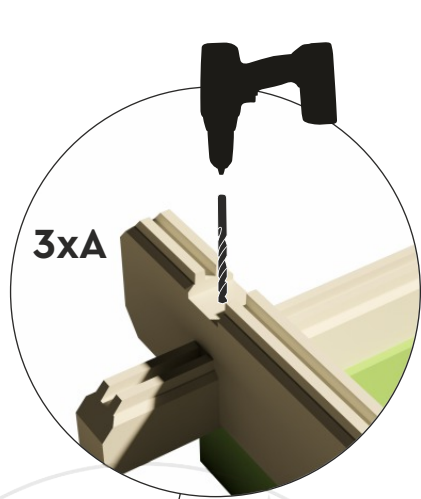

VENEZIA 40

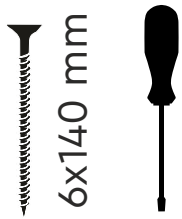
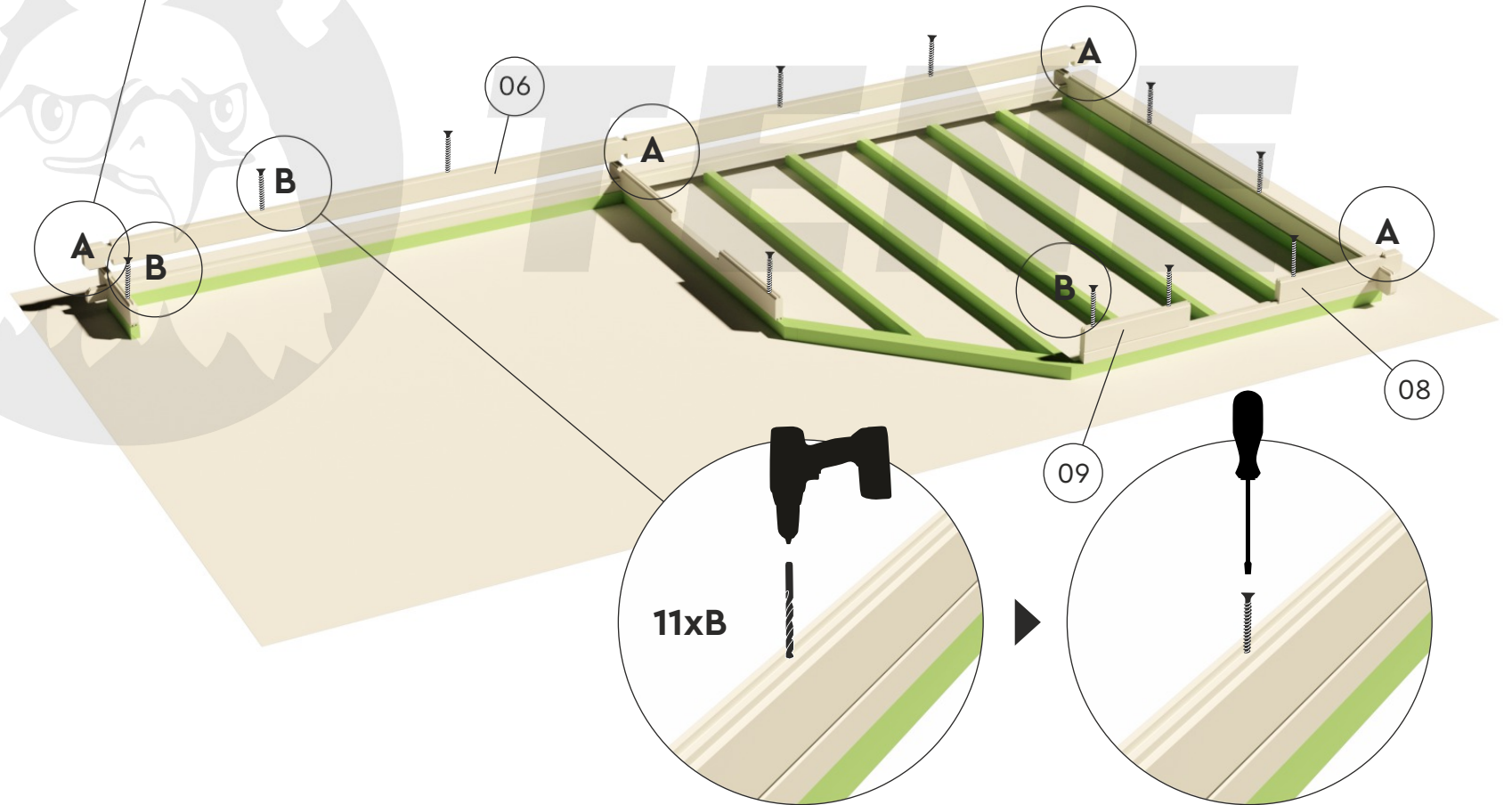
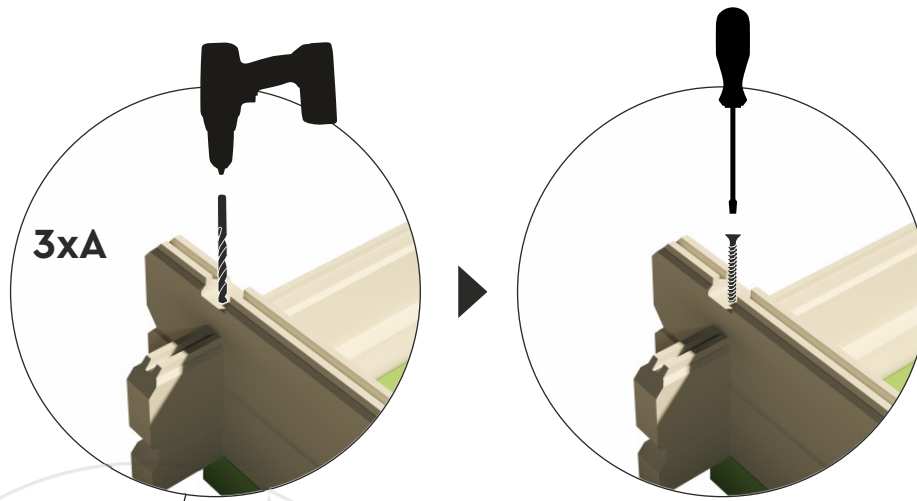

VENEZIA 40

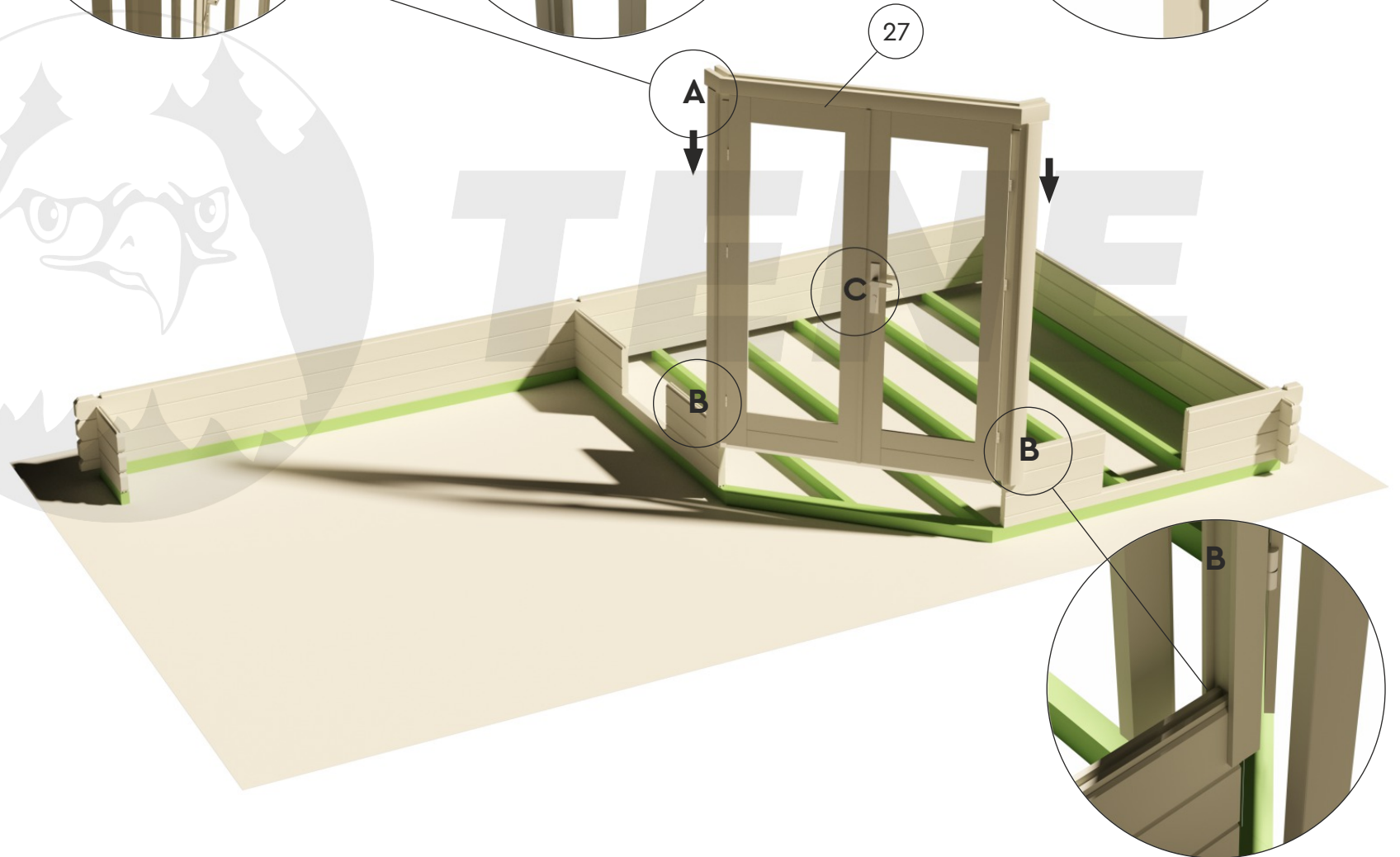
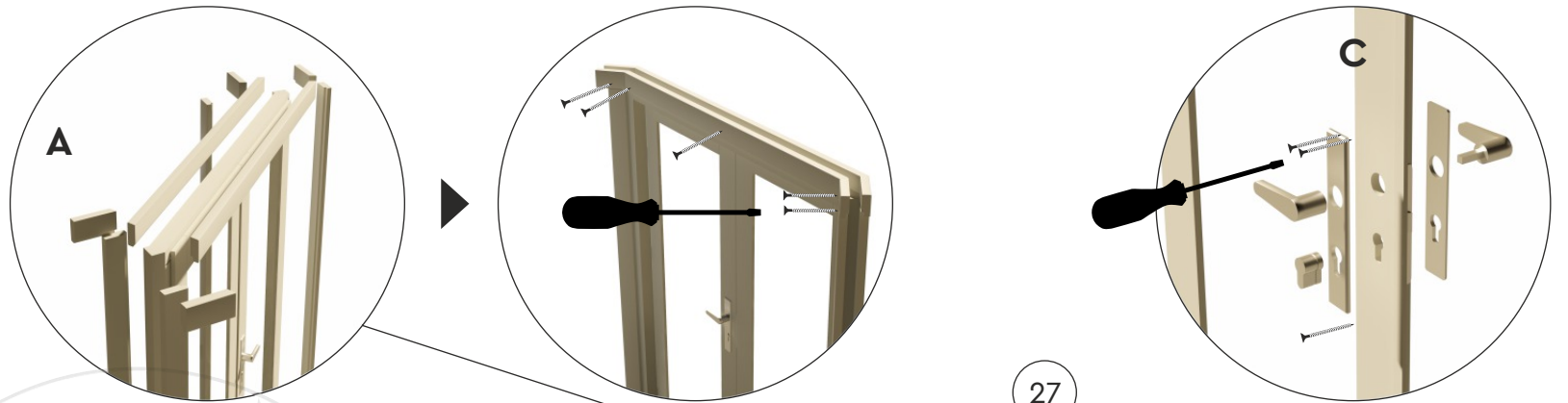

4x40 mm



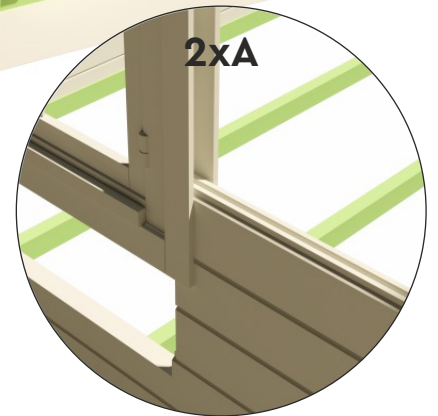
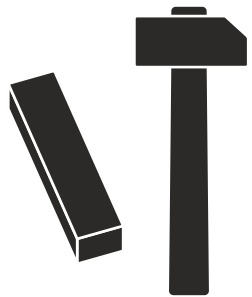
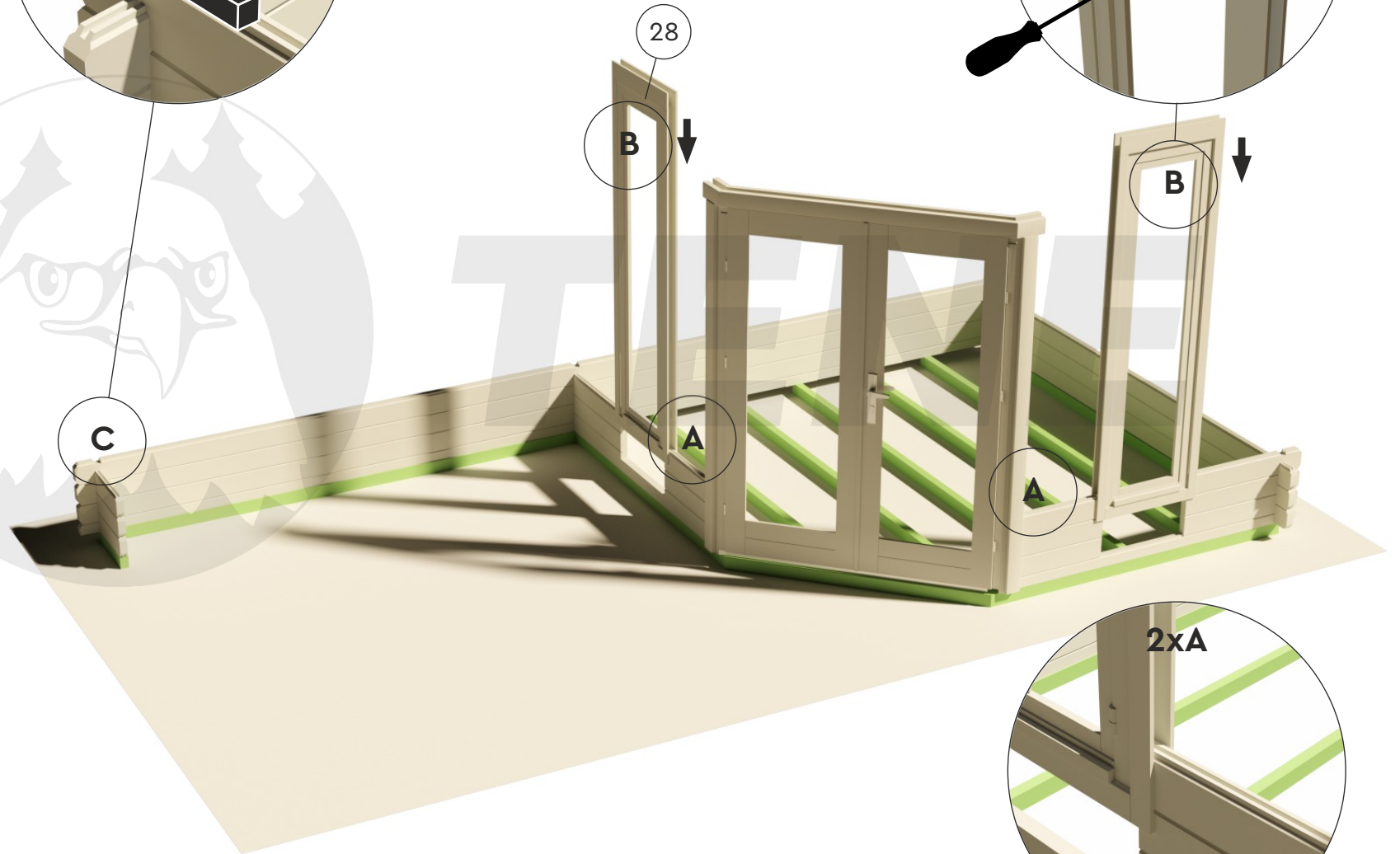
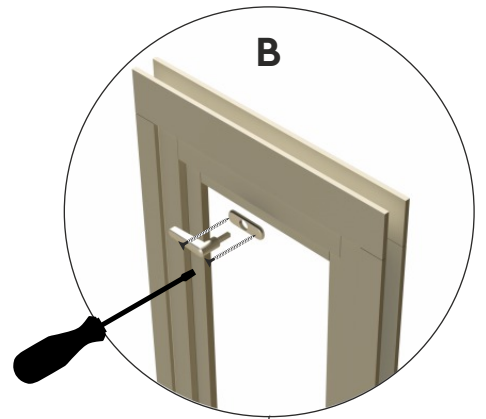
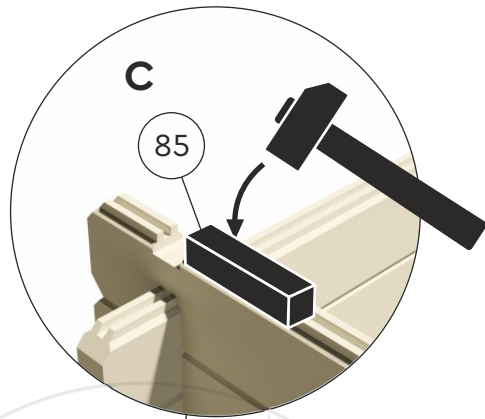

VENEZIA 40

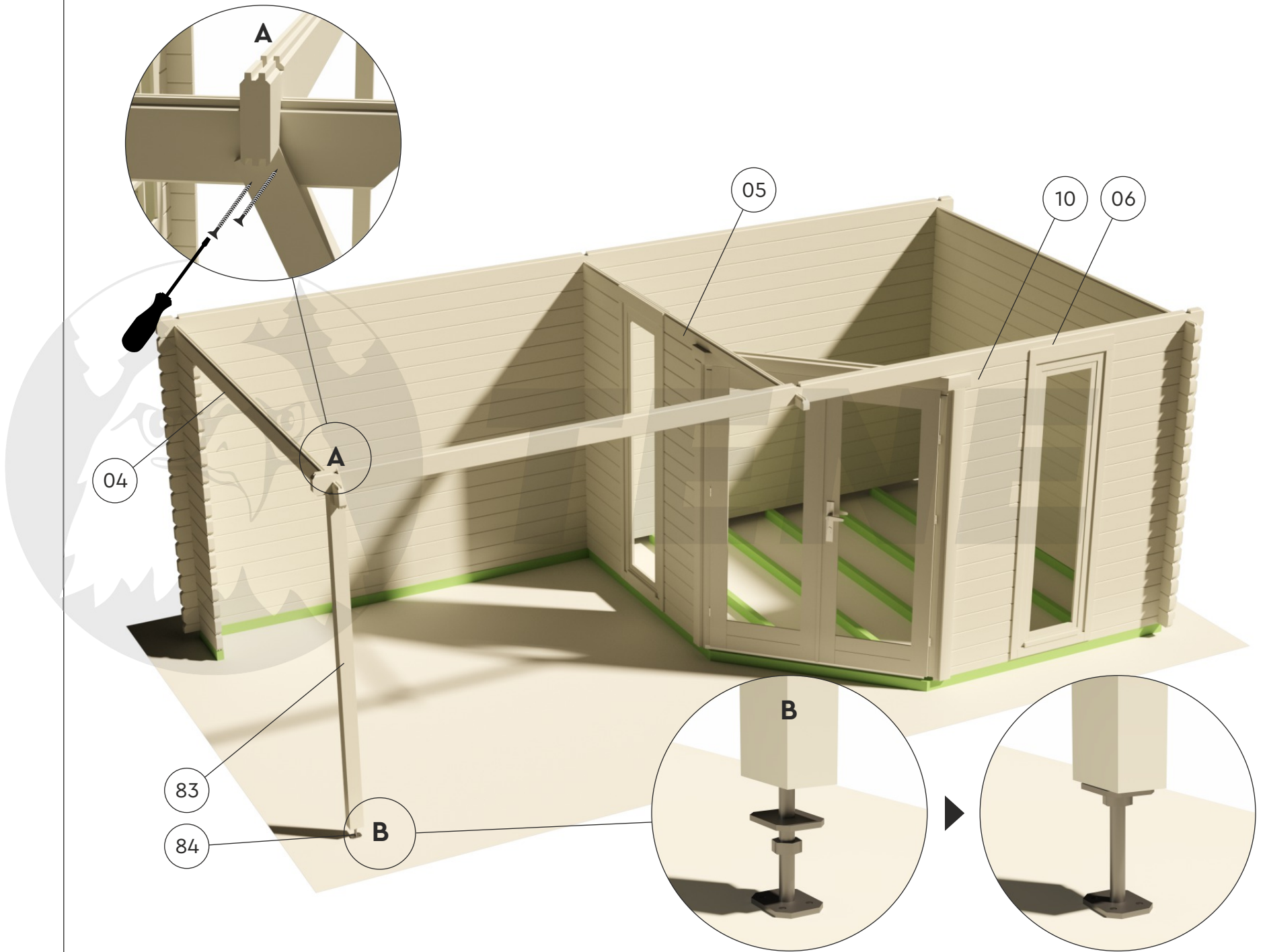

4x40 mm



VENEZIA 40

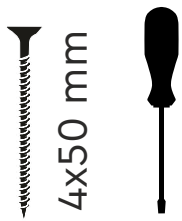
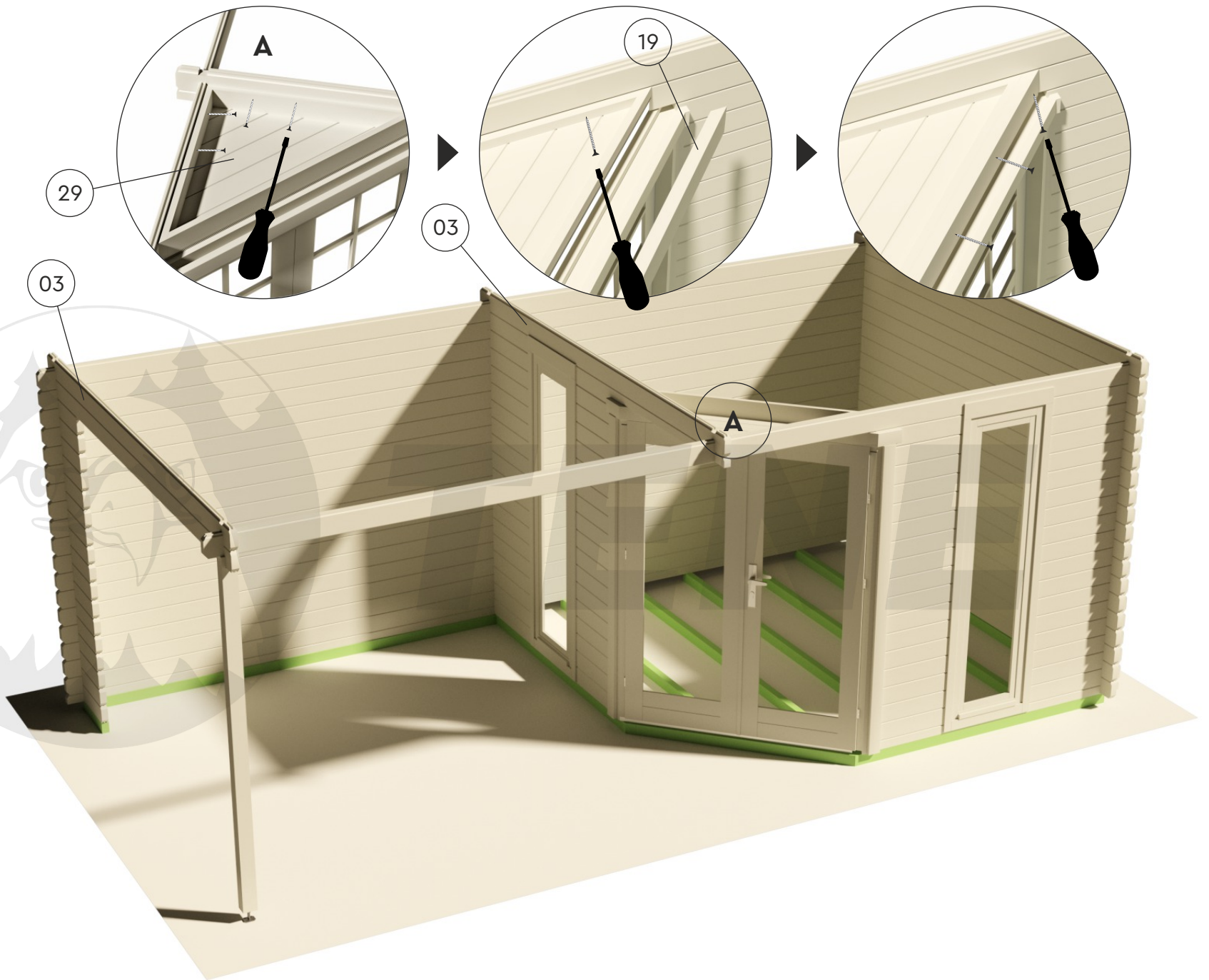



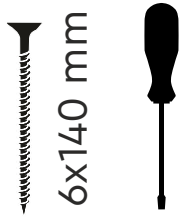
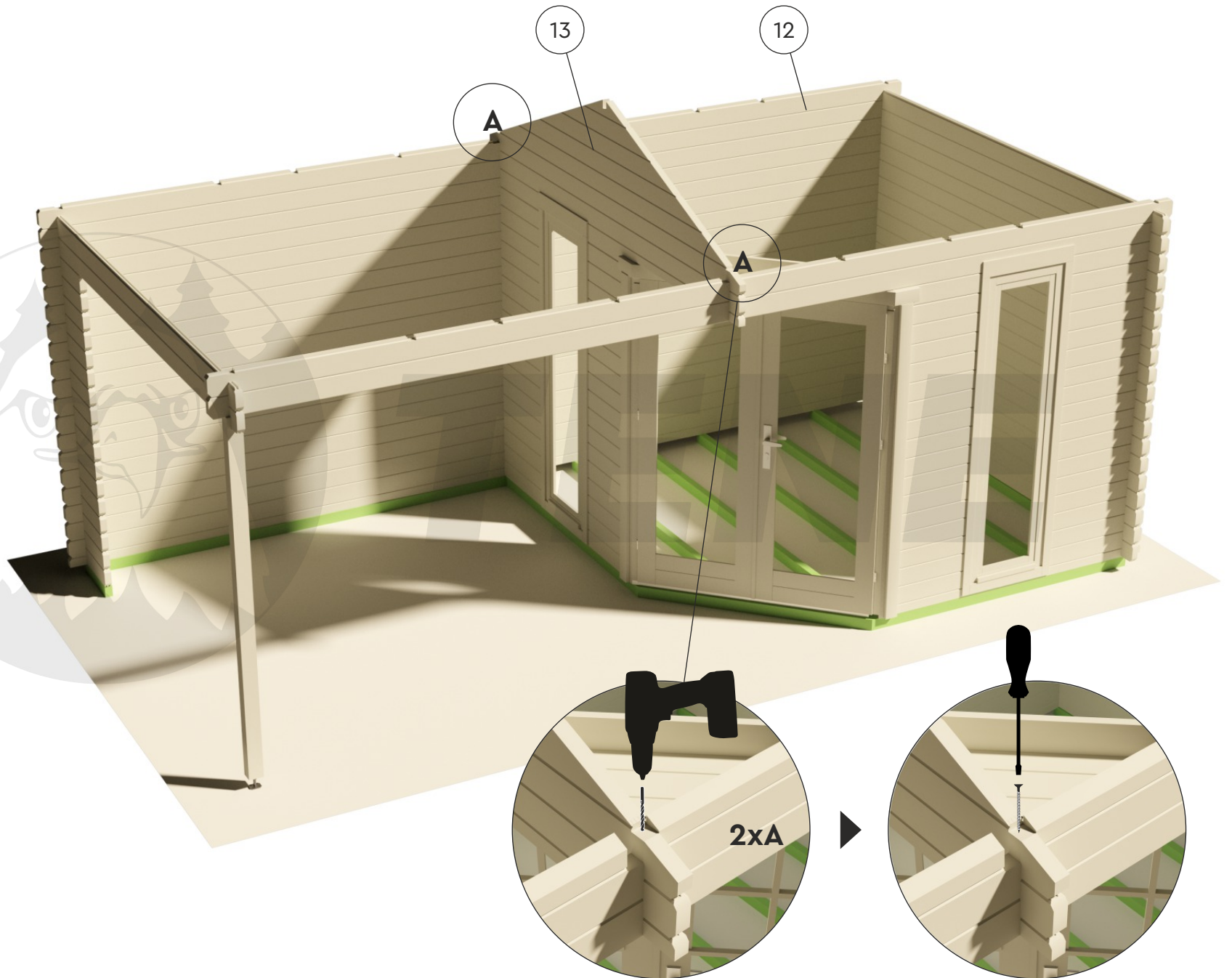

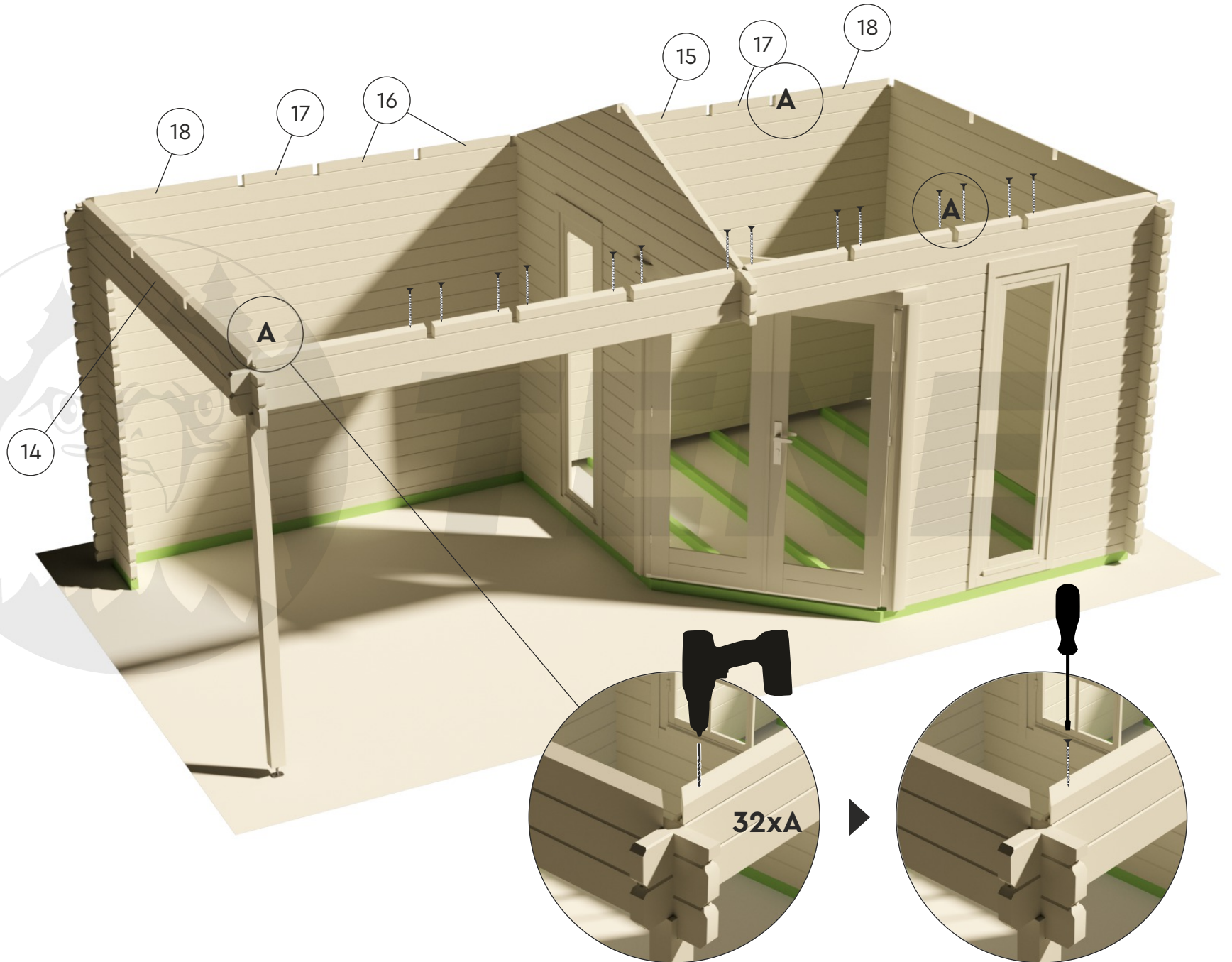

VENEZIA 40



VENEZIA 40



VENEZIA 40

-  $\varnothing 5 \text{ mm}$
 -  $\varnothing 4 \text{ mm}$
 -  $6 \times 140 \text{ mm}$
 -  $5 \times 70 \text{ mm}$
- 
- 

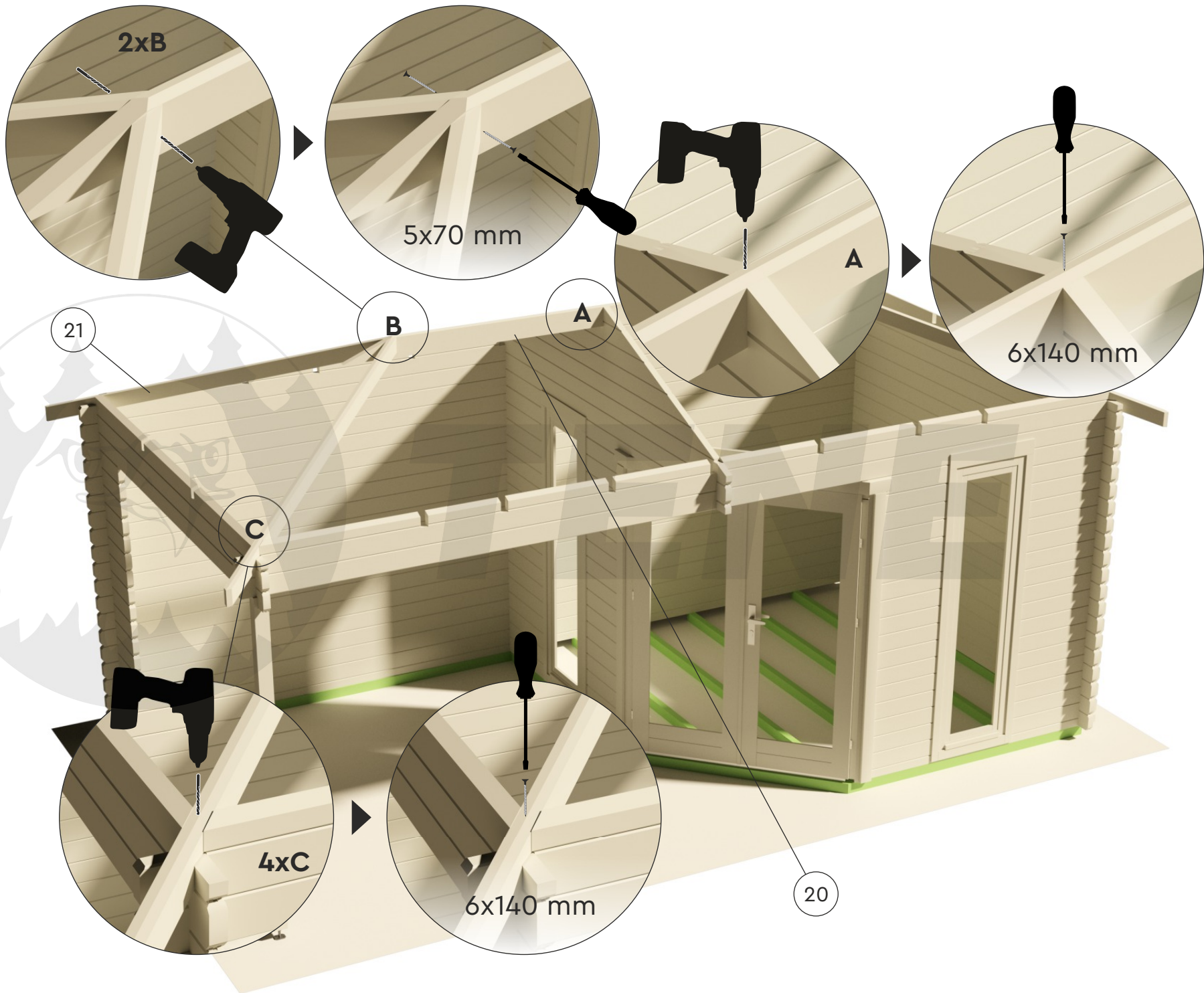

VENEZIA 40

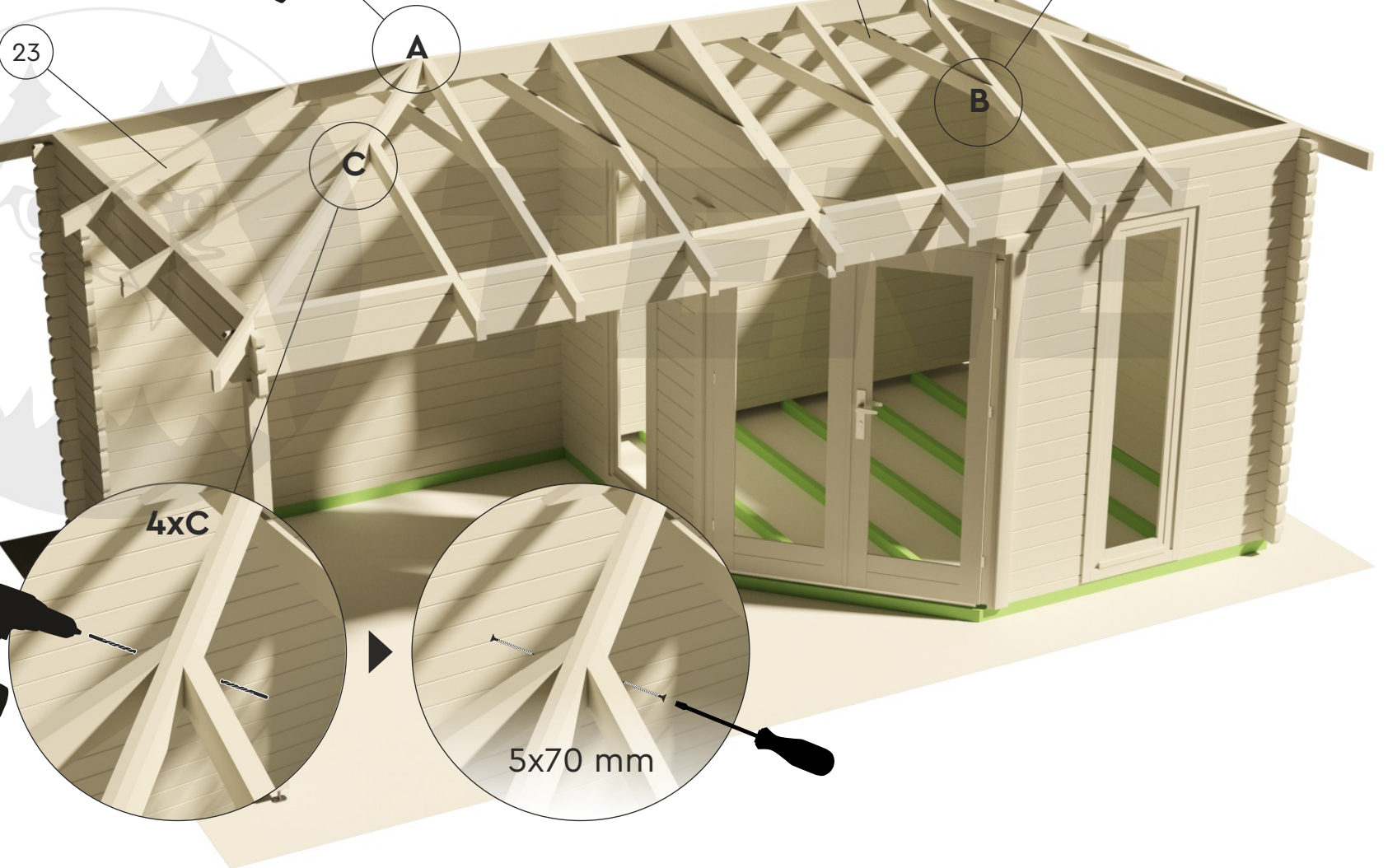
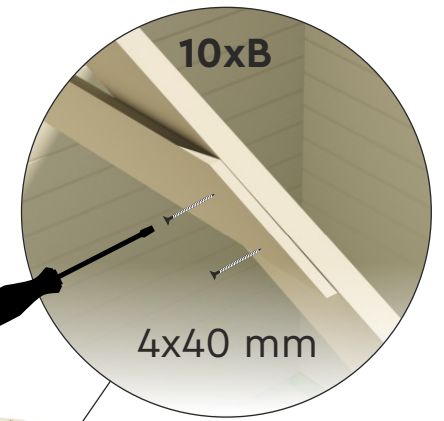
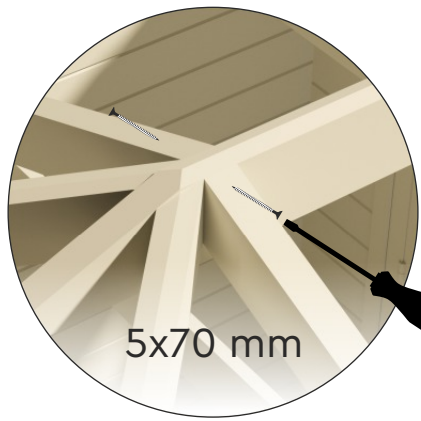
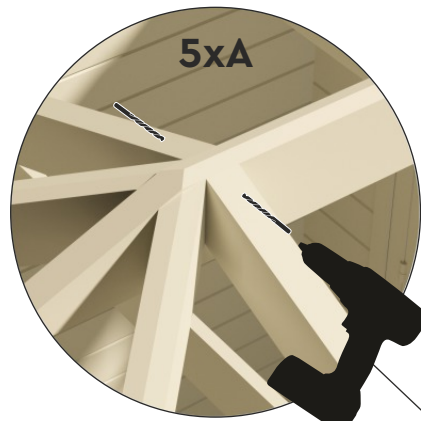

Ø 3 mm



Ø 4 mm



4x40 mm



5x70 mm



VENEZIA 40

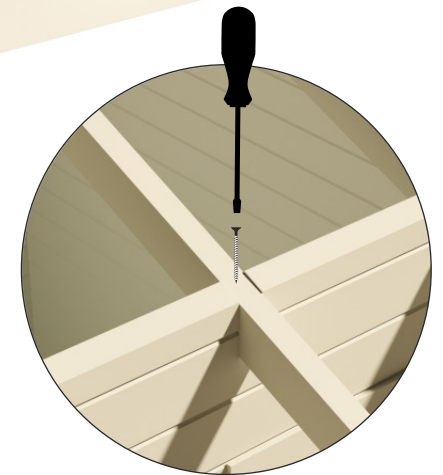
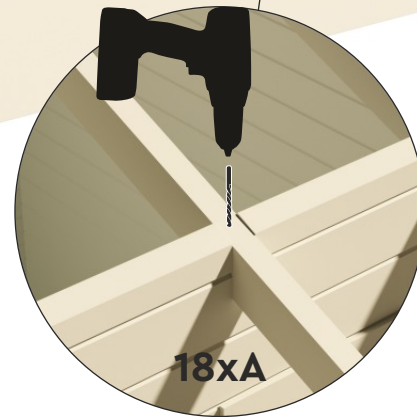
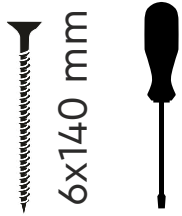
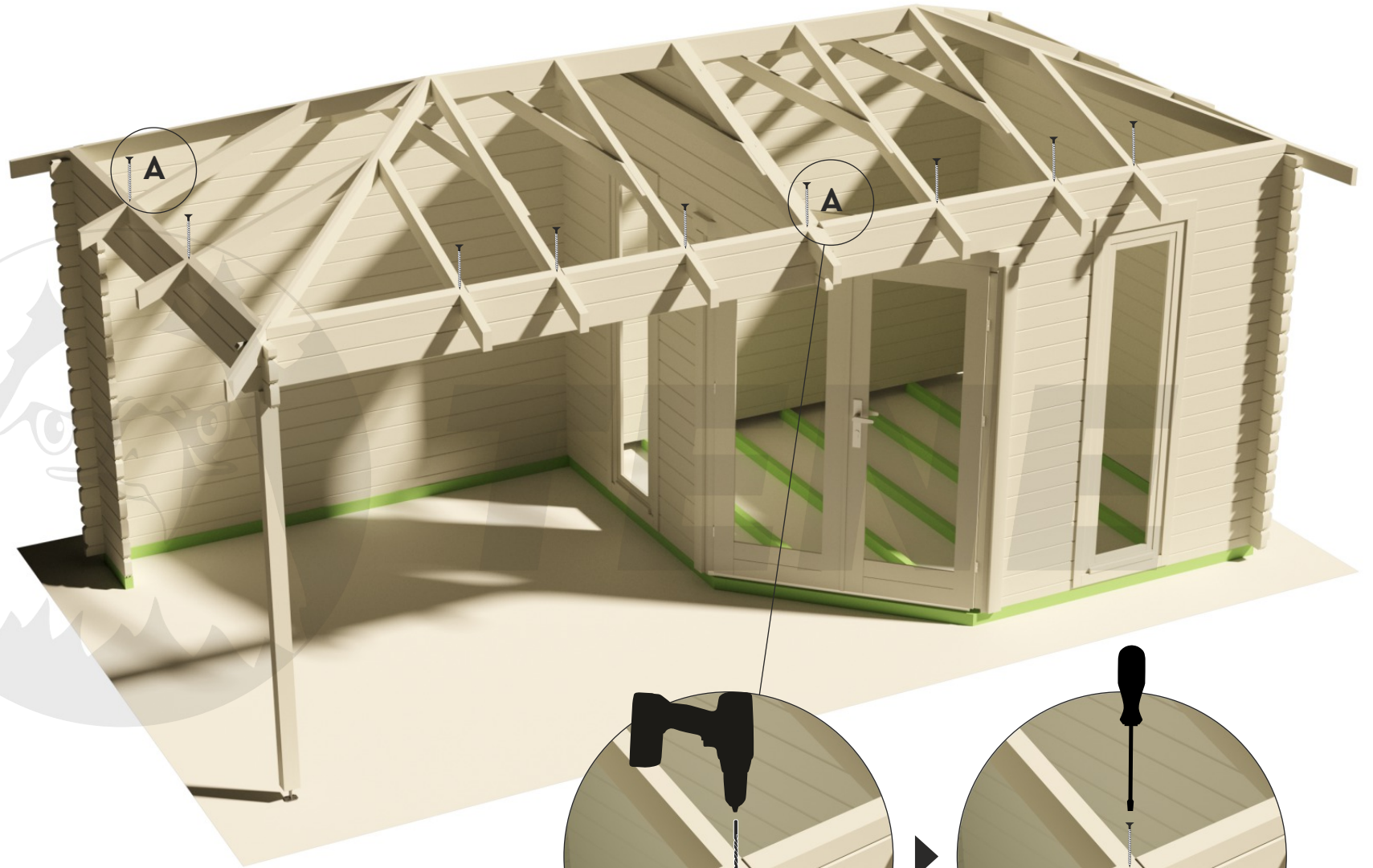

VENEZIA 40

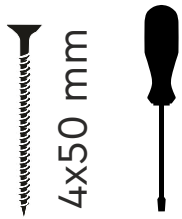
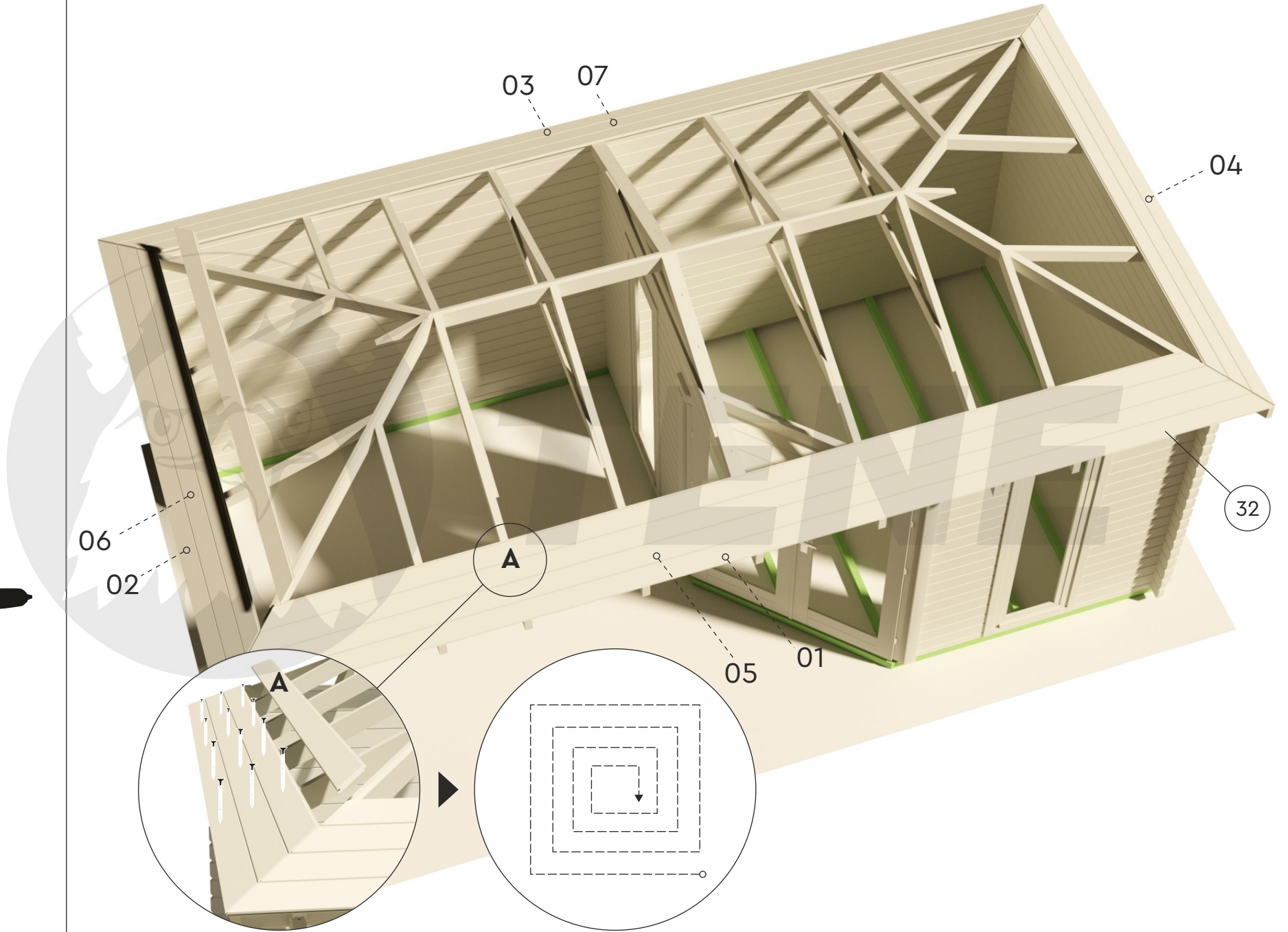

VENEZIA 40

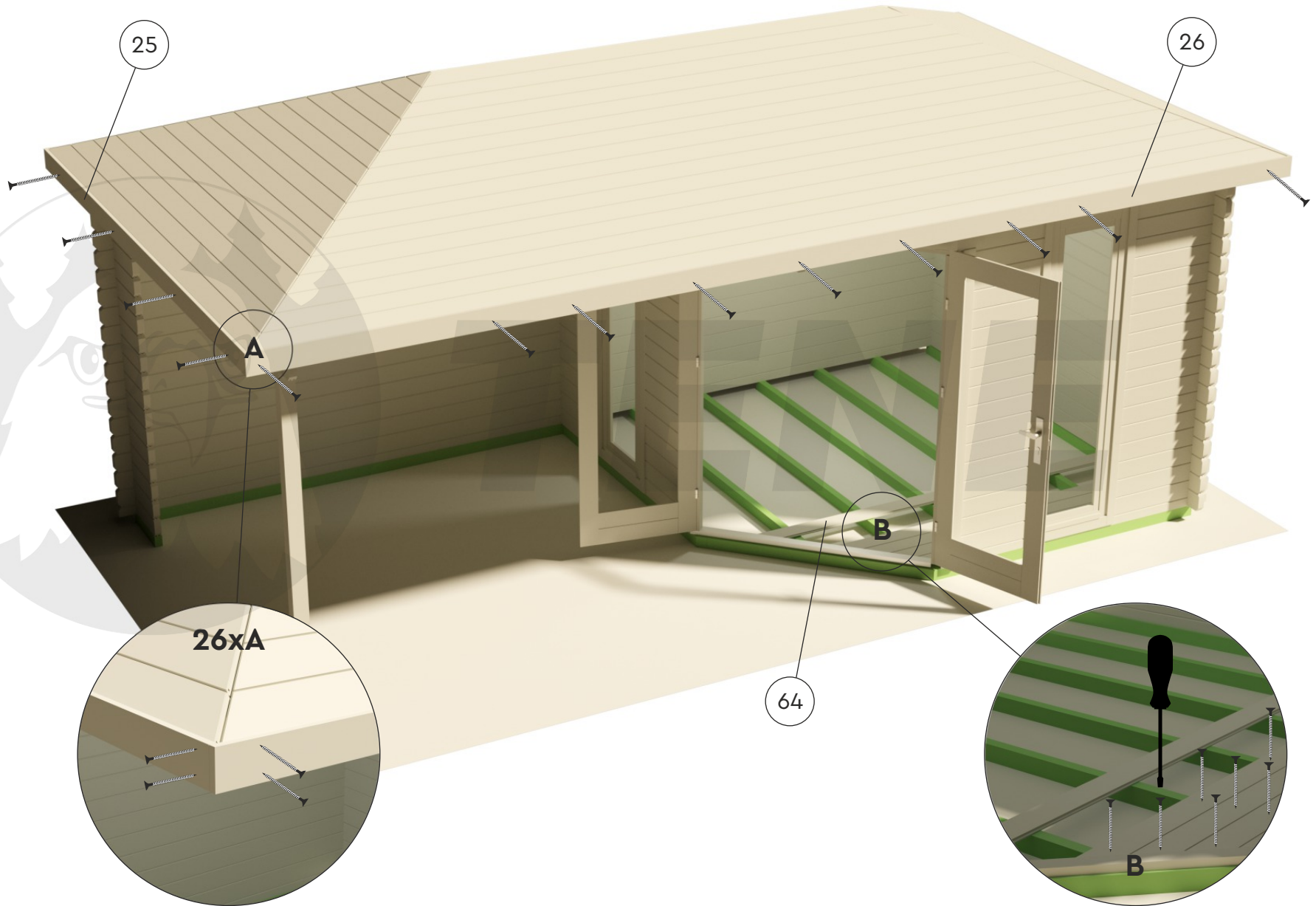
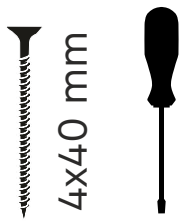

VENEZIA 40

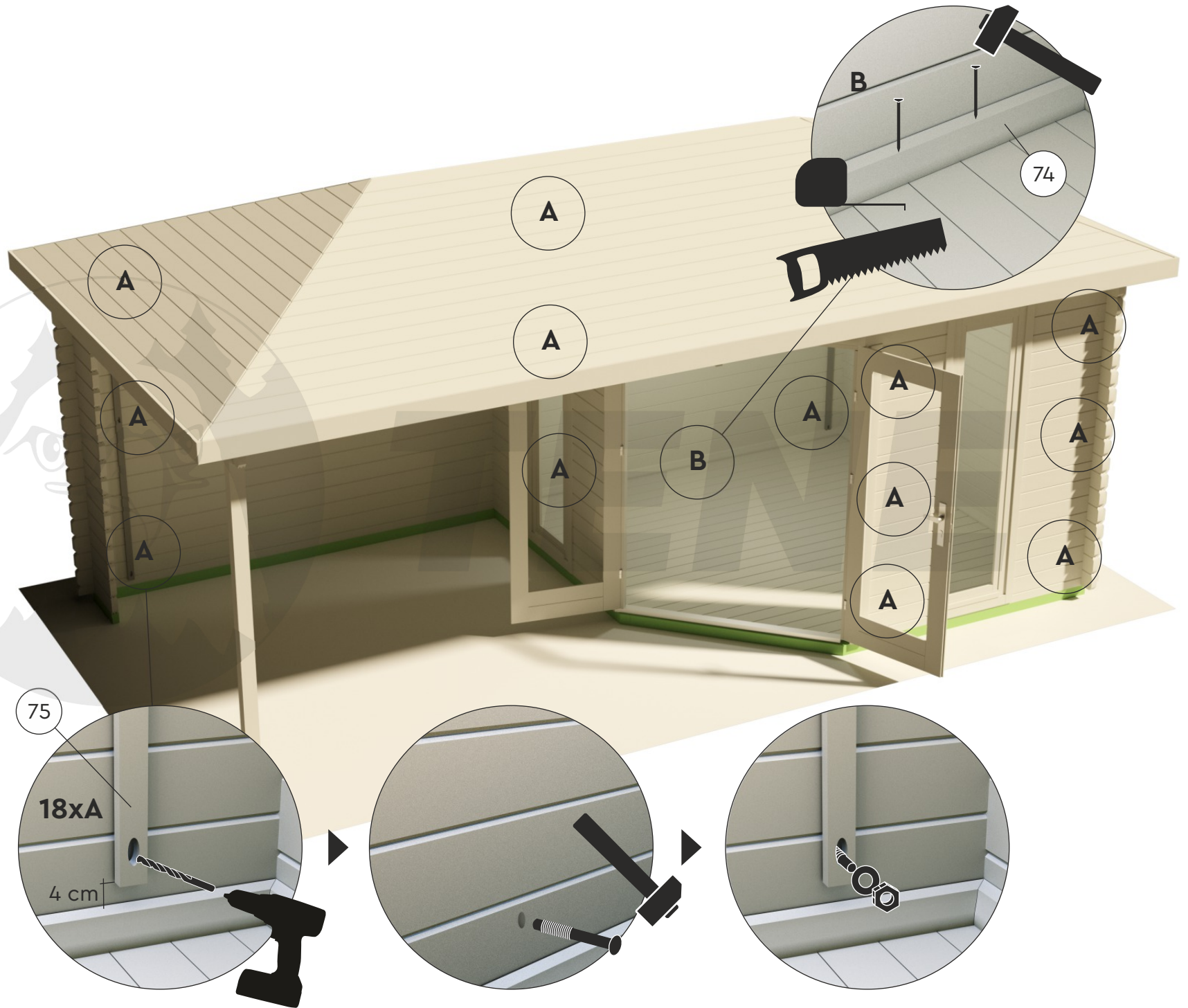

VENEZIA 40

