

VICTORIA B 40

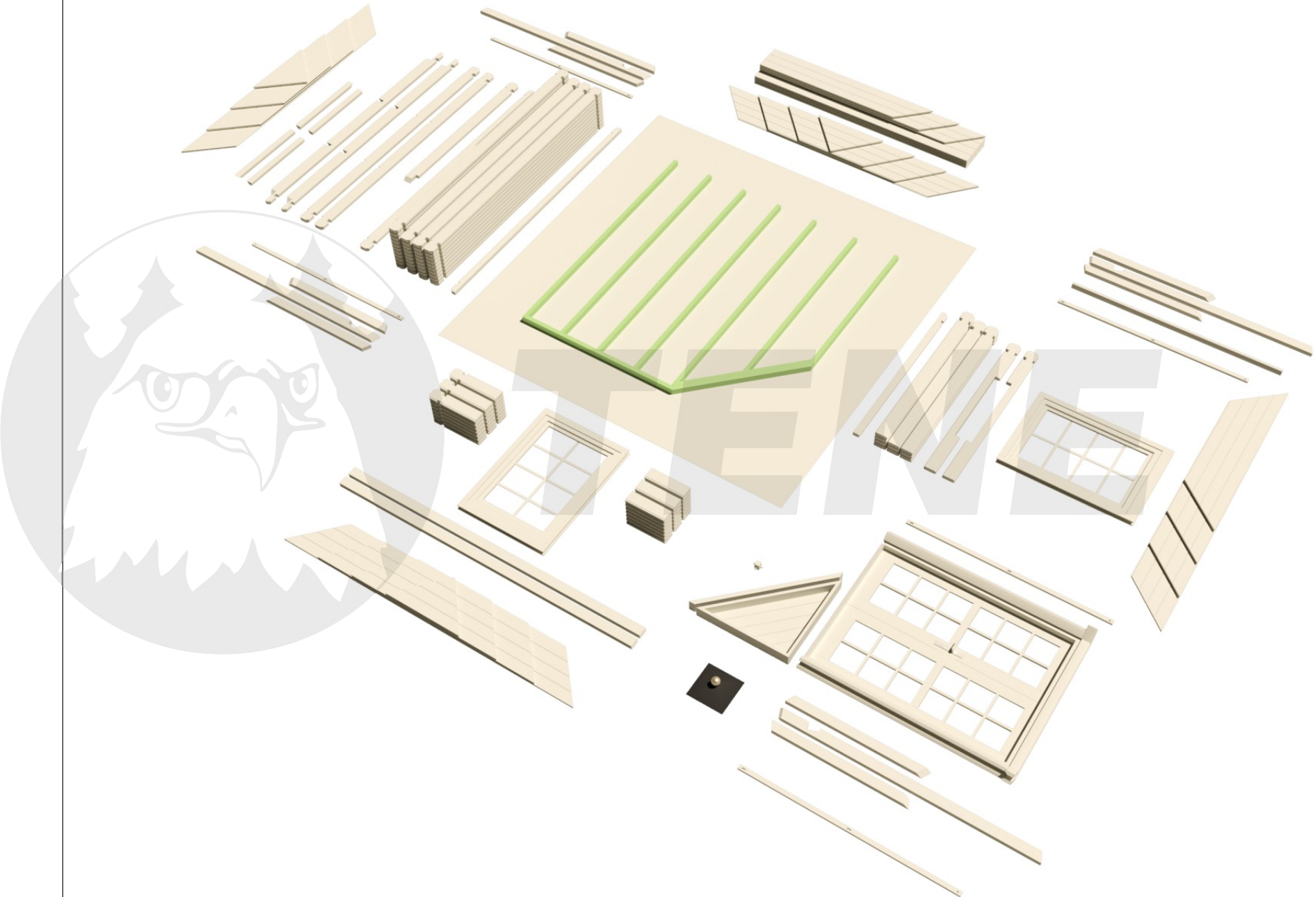

VICTORIA B 40

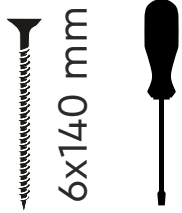

6x140 mm

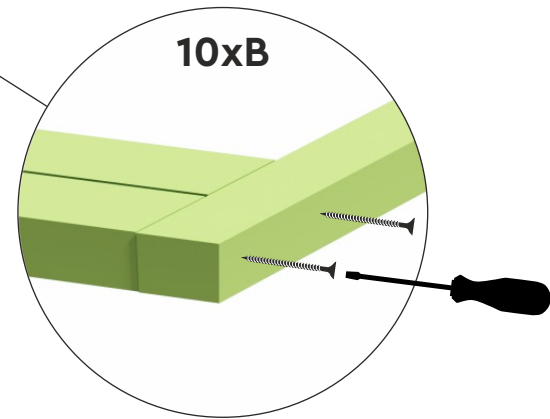
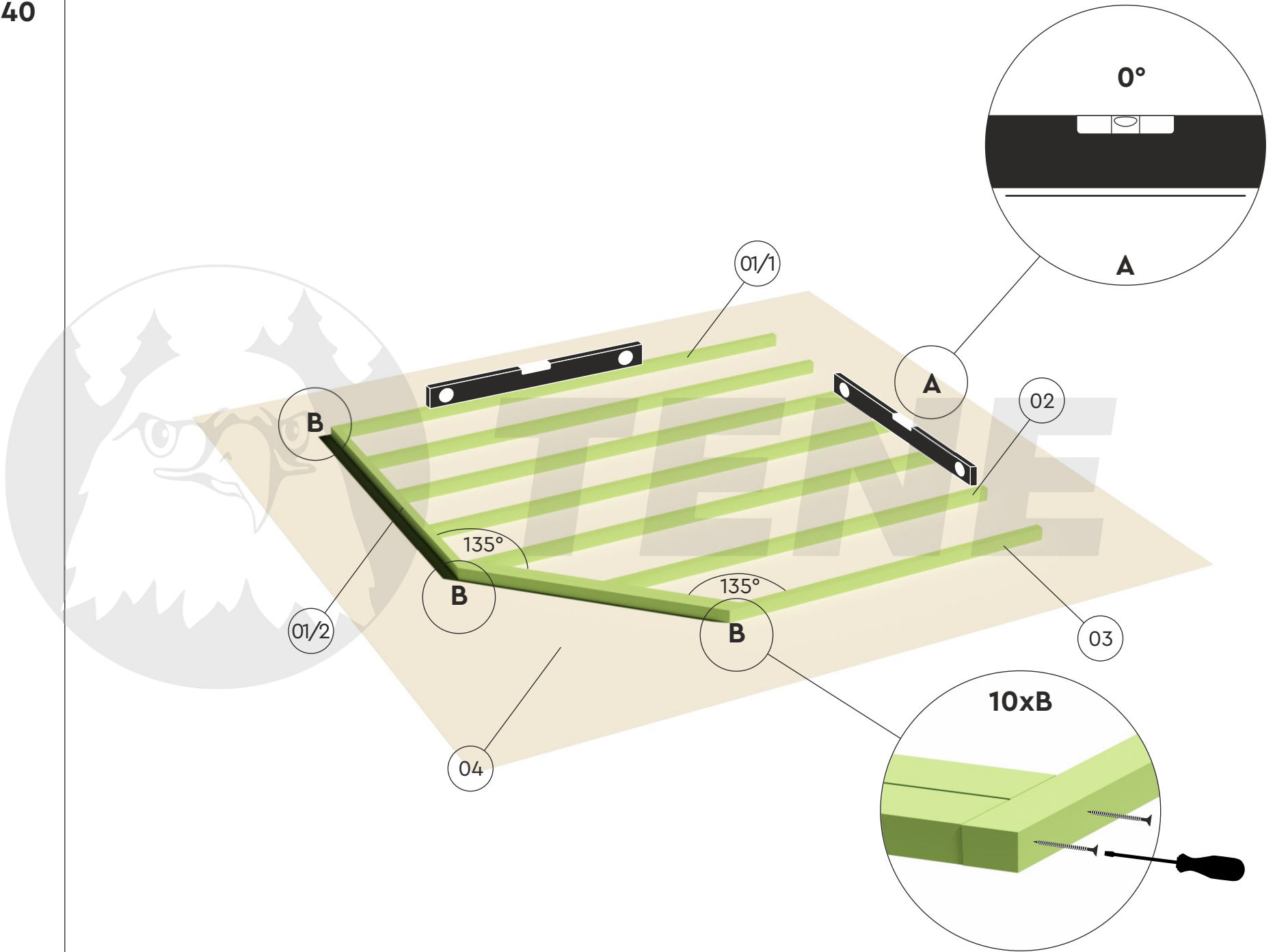

VICTORIA B 40

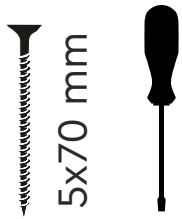
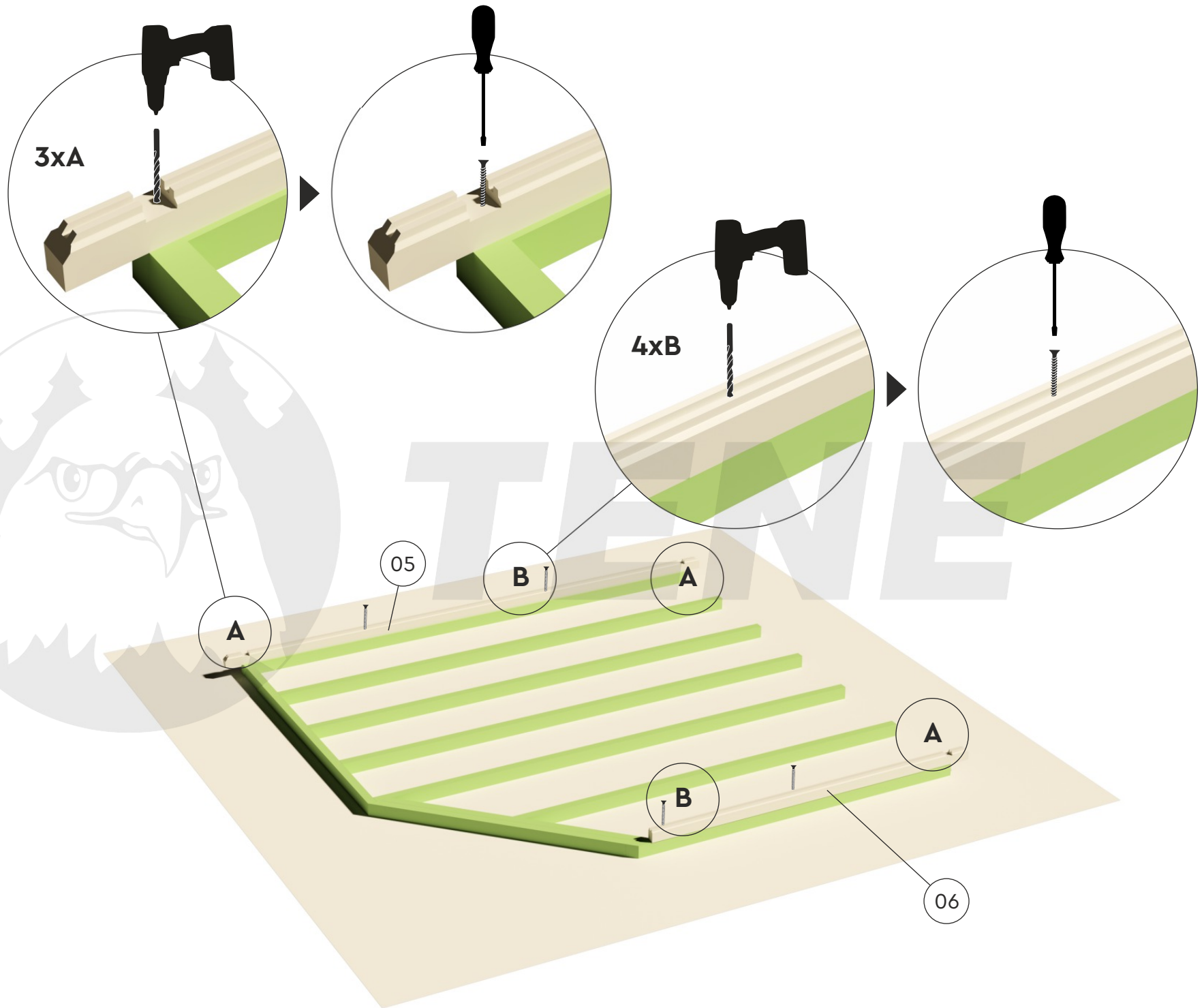

VICTORIA B 40

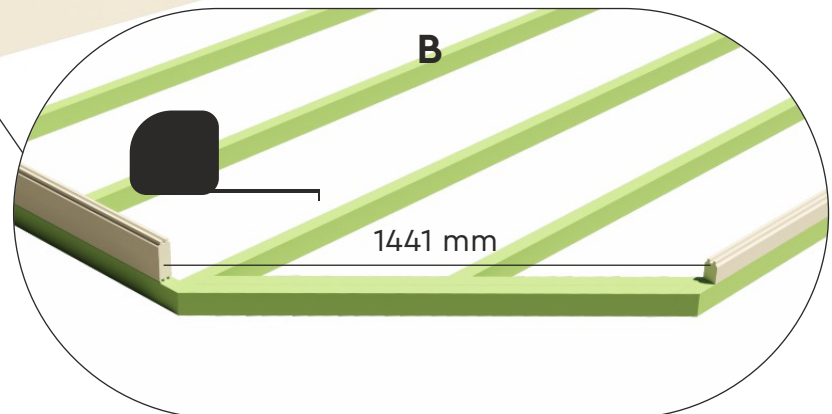
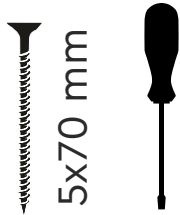
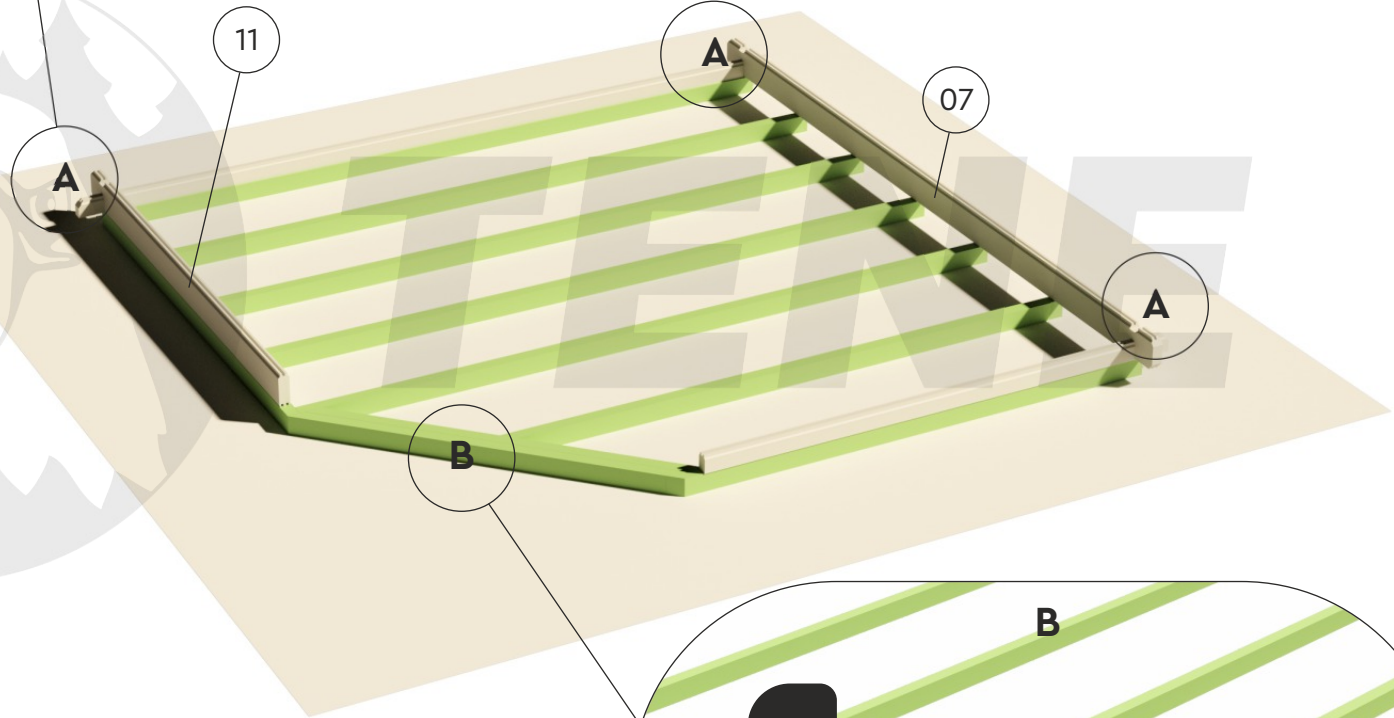
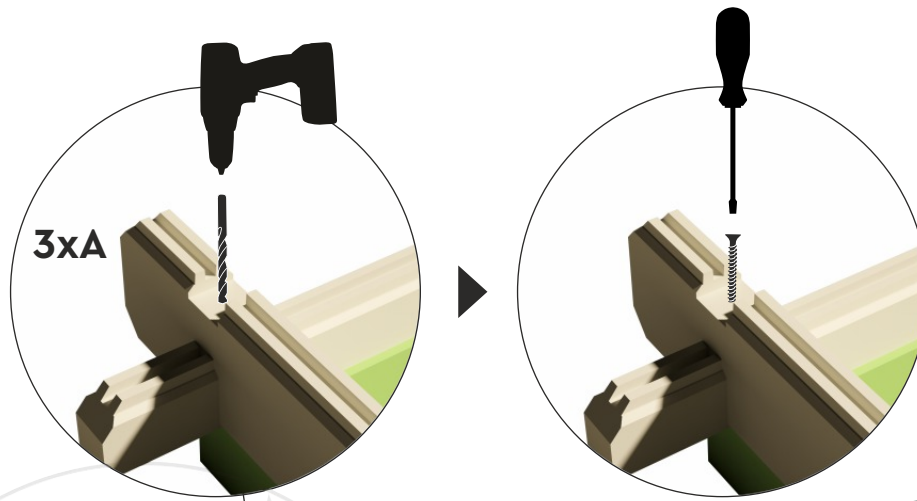

VICTORIA B 40

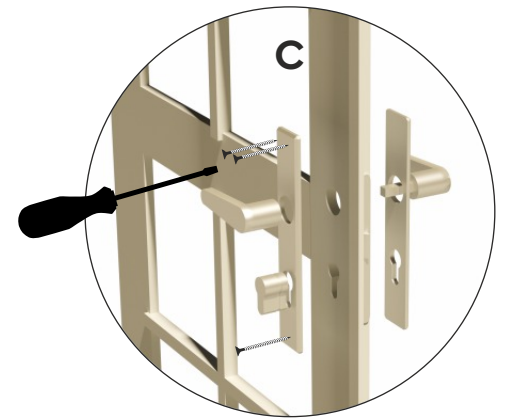
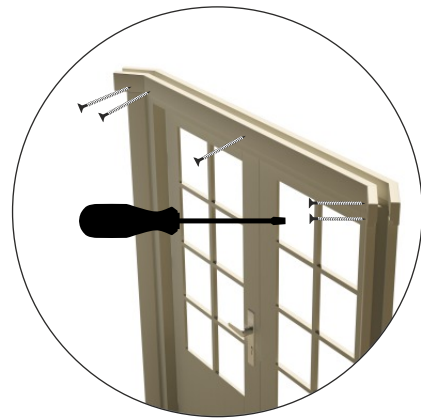
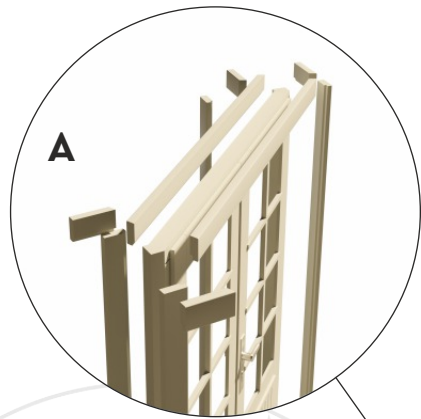

A

24

C

B

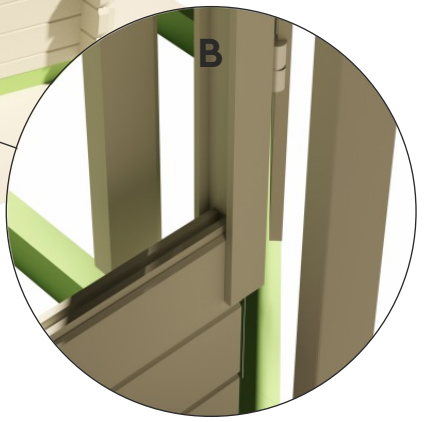

4x40 mm



VICTORIA B 40

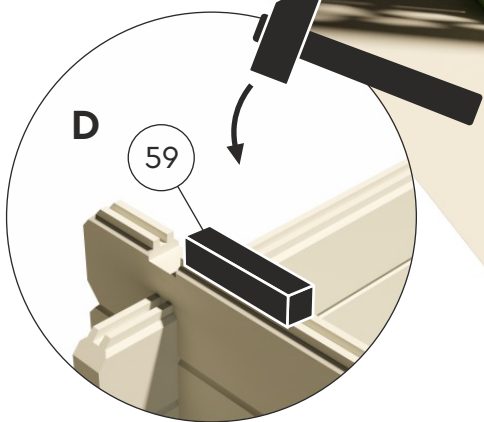
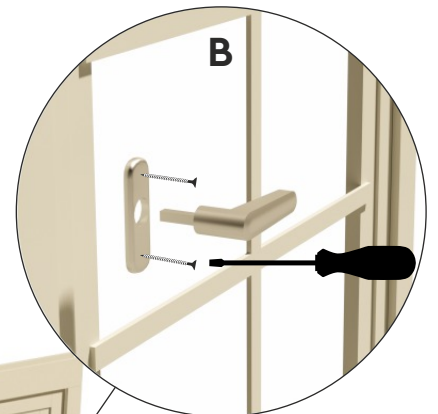
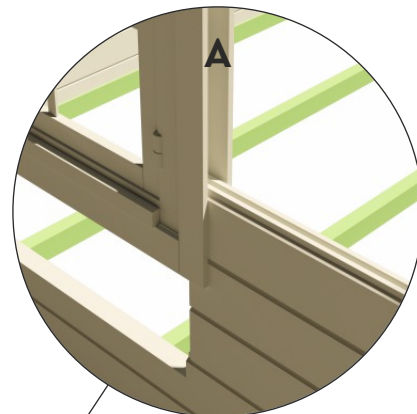
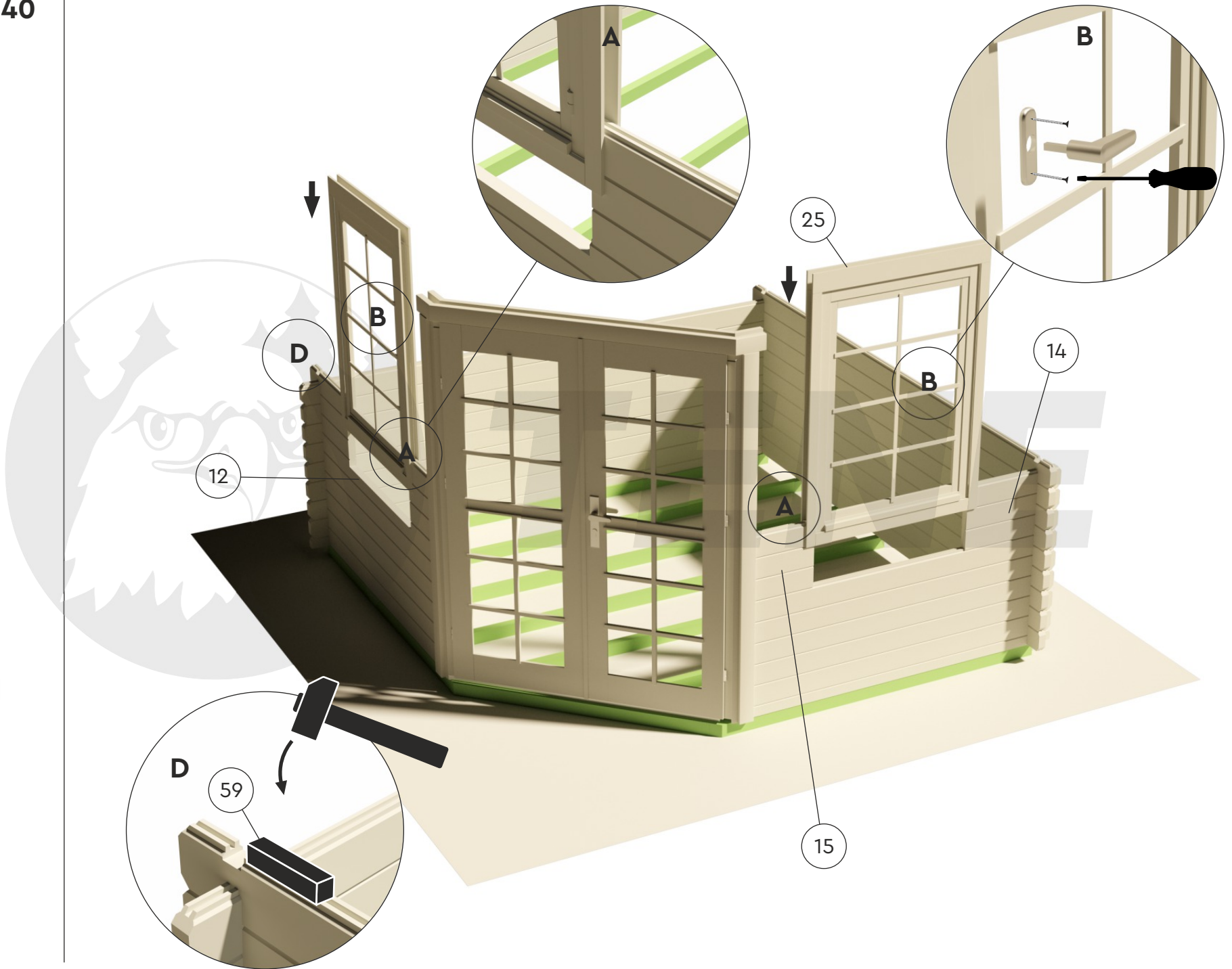
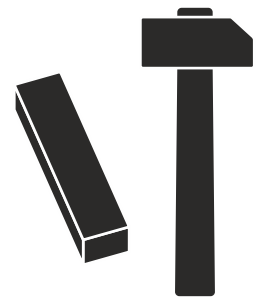

VICTORIA B 40

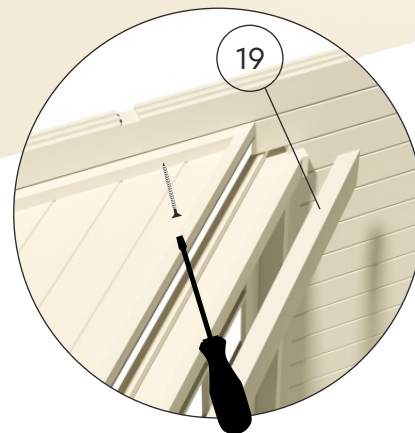
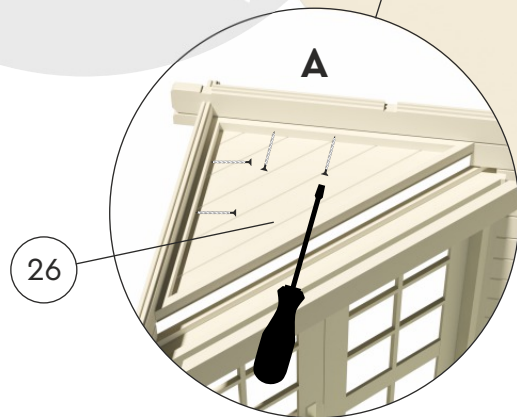
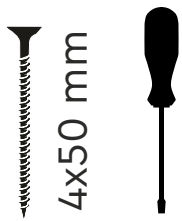

VICTORIA B 40

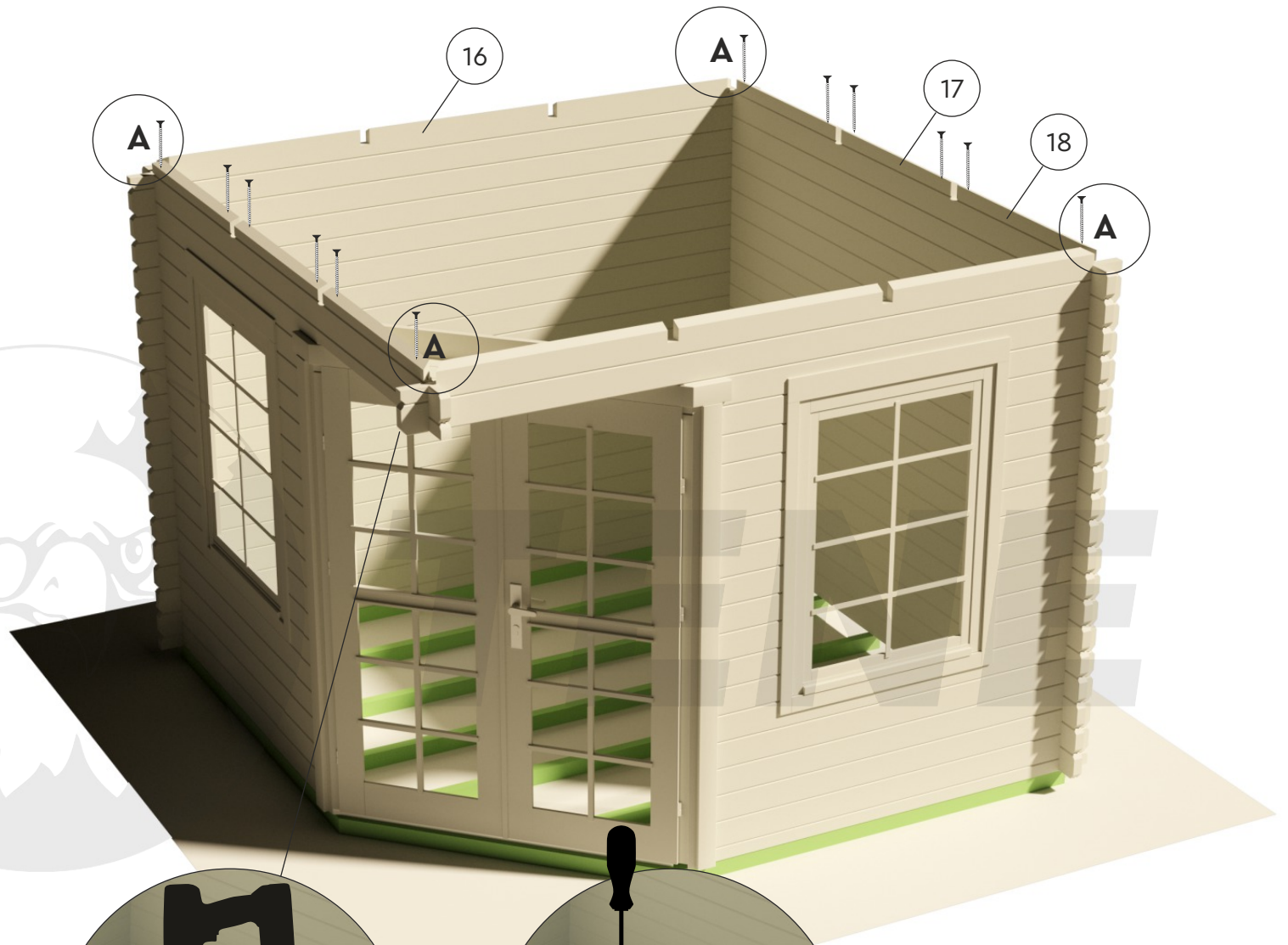

Ø 4 mm

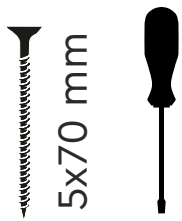

5x70 mm



12xA

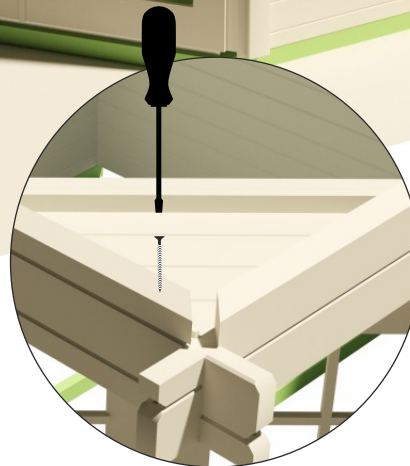

VICTORIA B 40

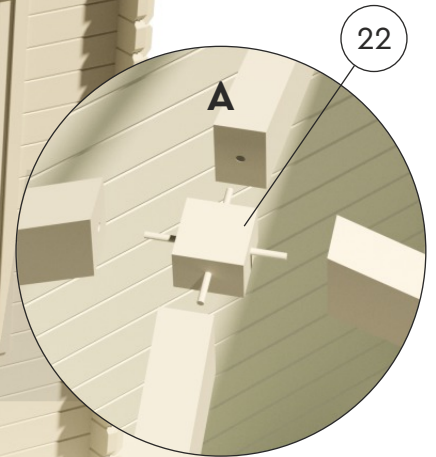
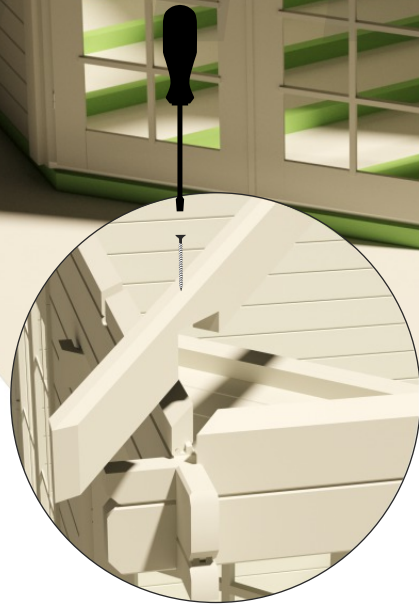
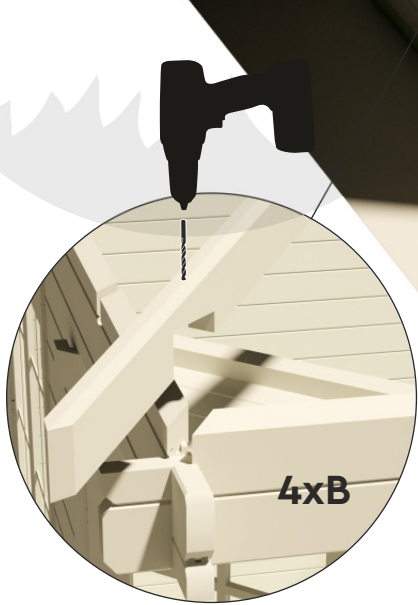
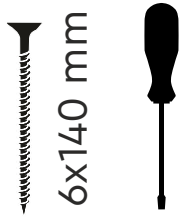
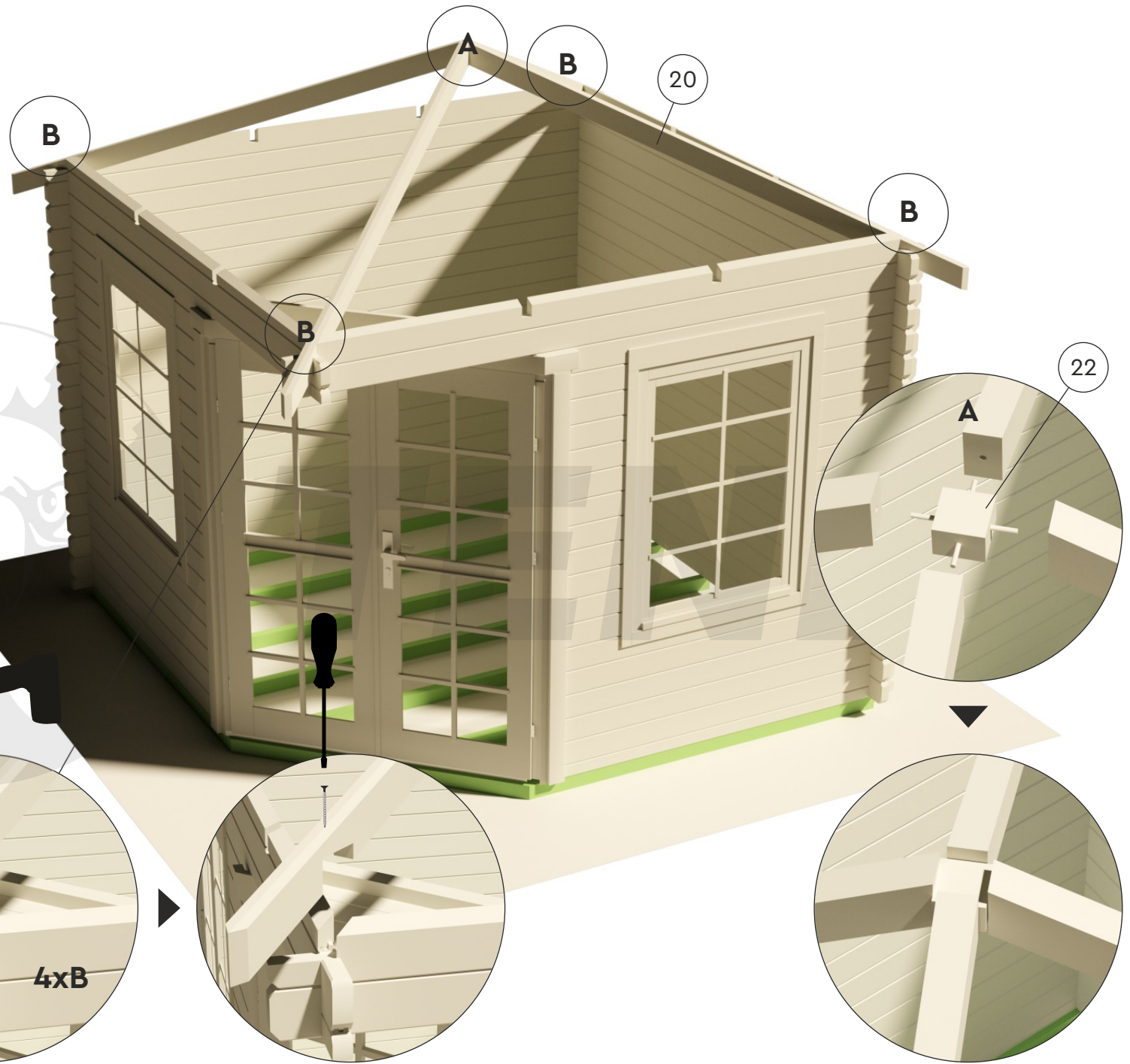

VICTORIA B 40

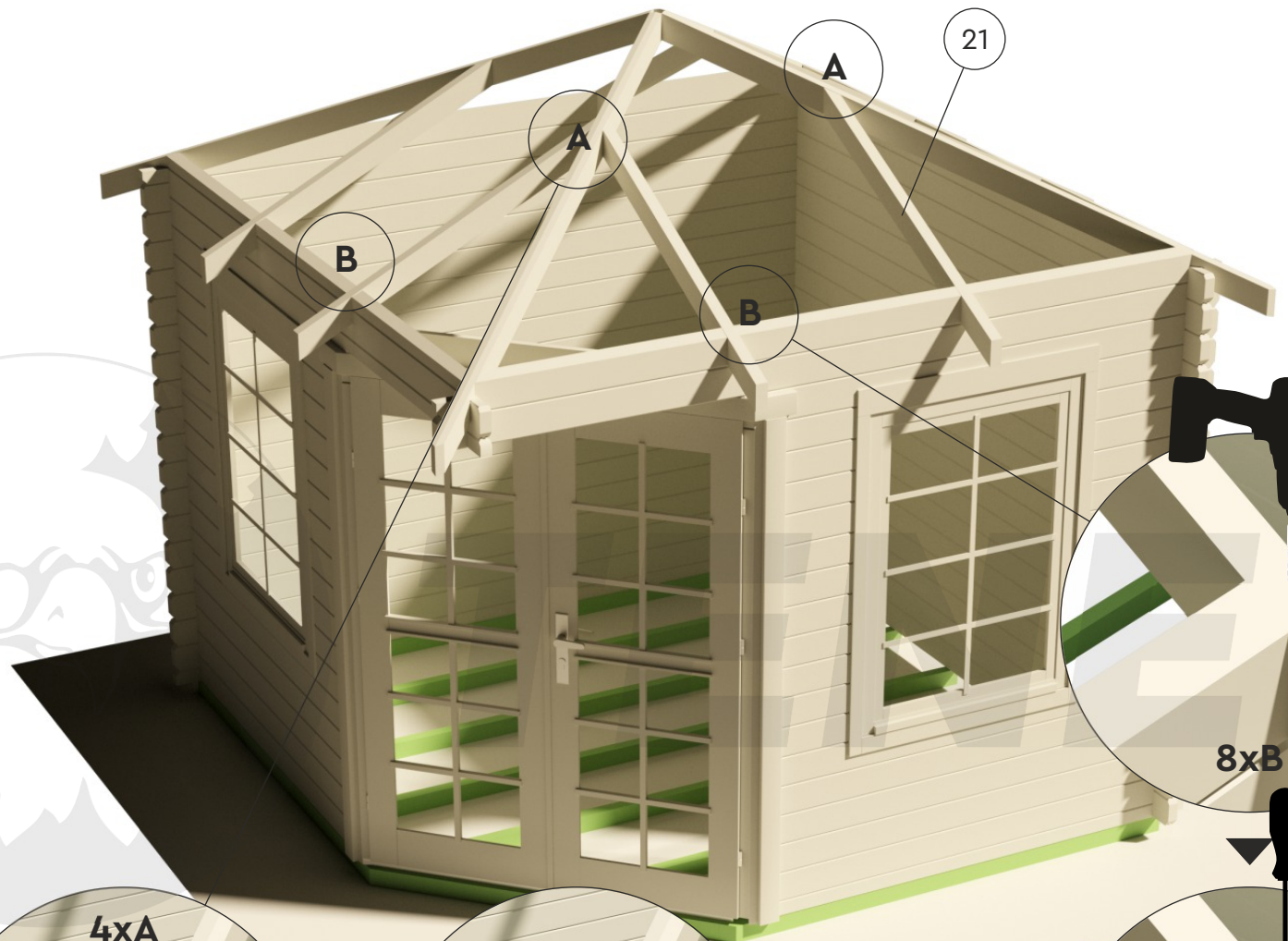

ø 5 mm



ø 4 mm



6x140 mm



5x70 mm

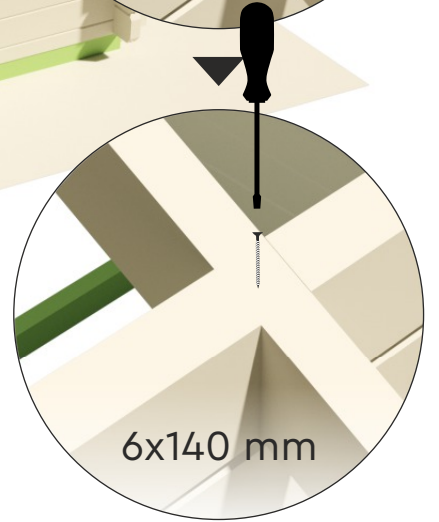
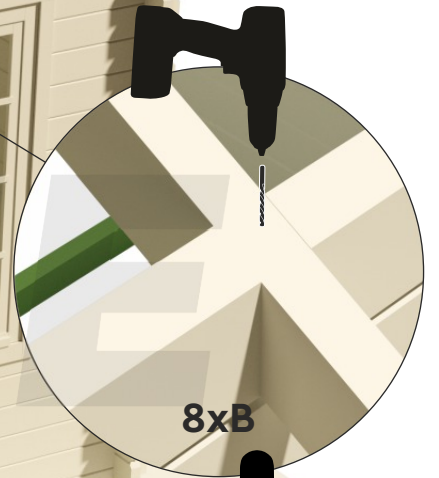
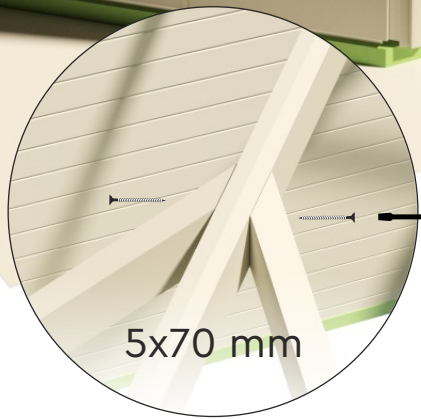
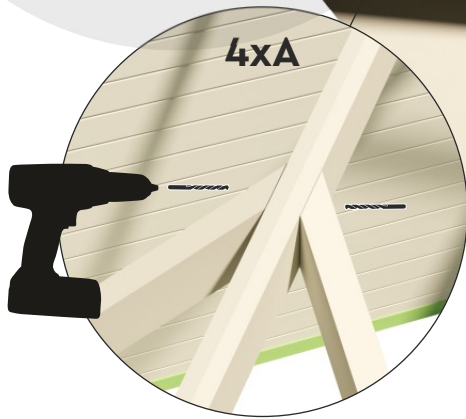

VICTORIA B 40

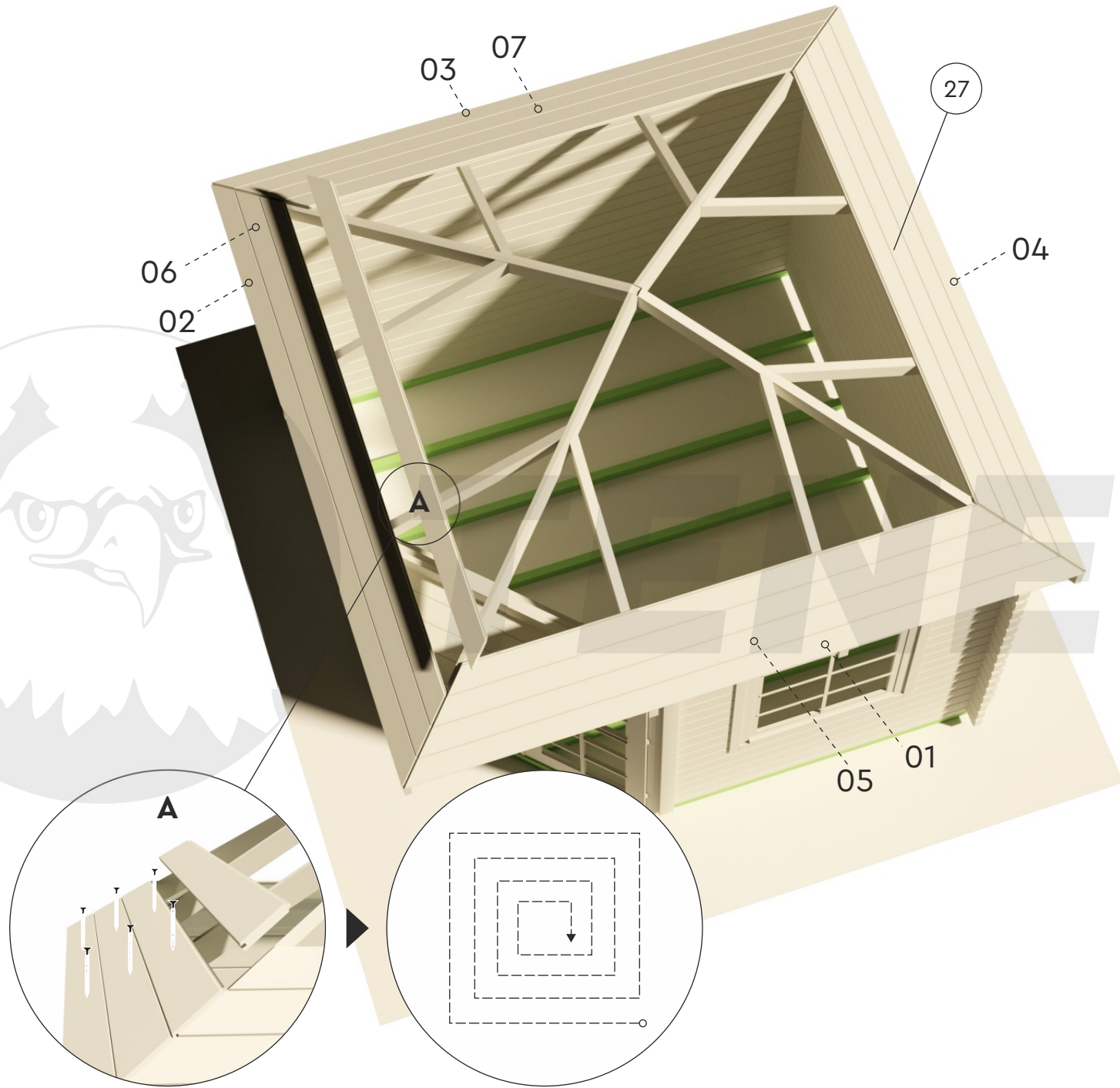
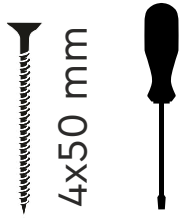
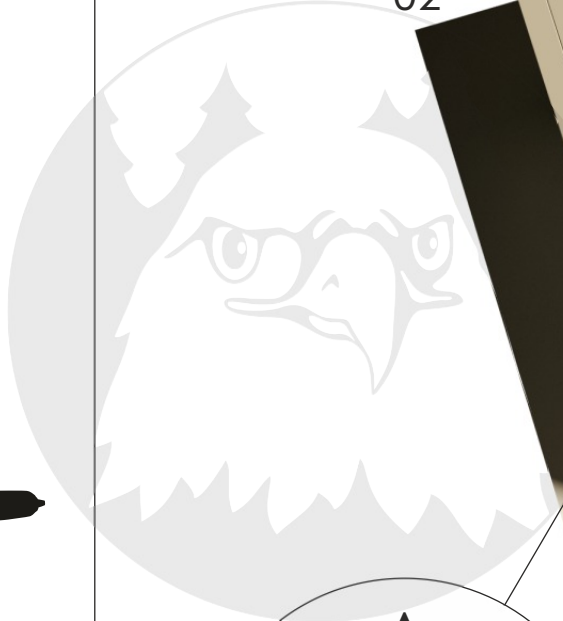

VICTORIA B 40

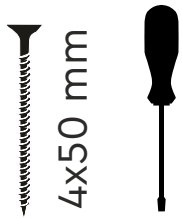
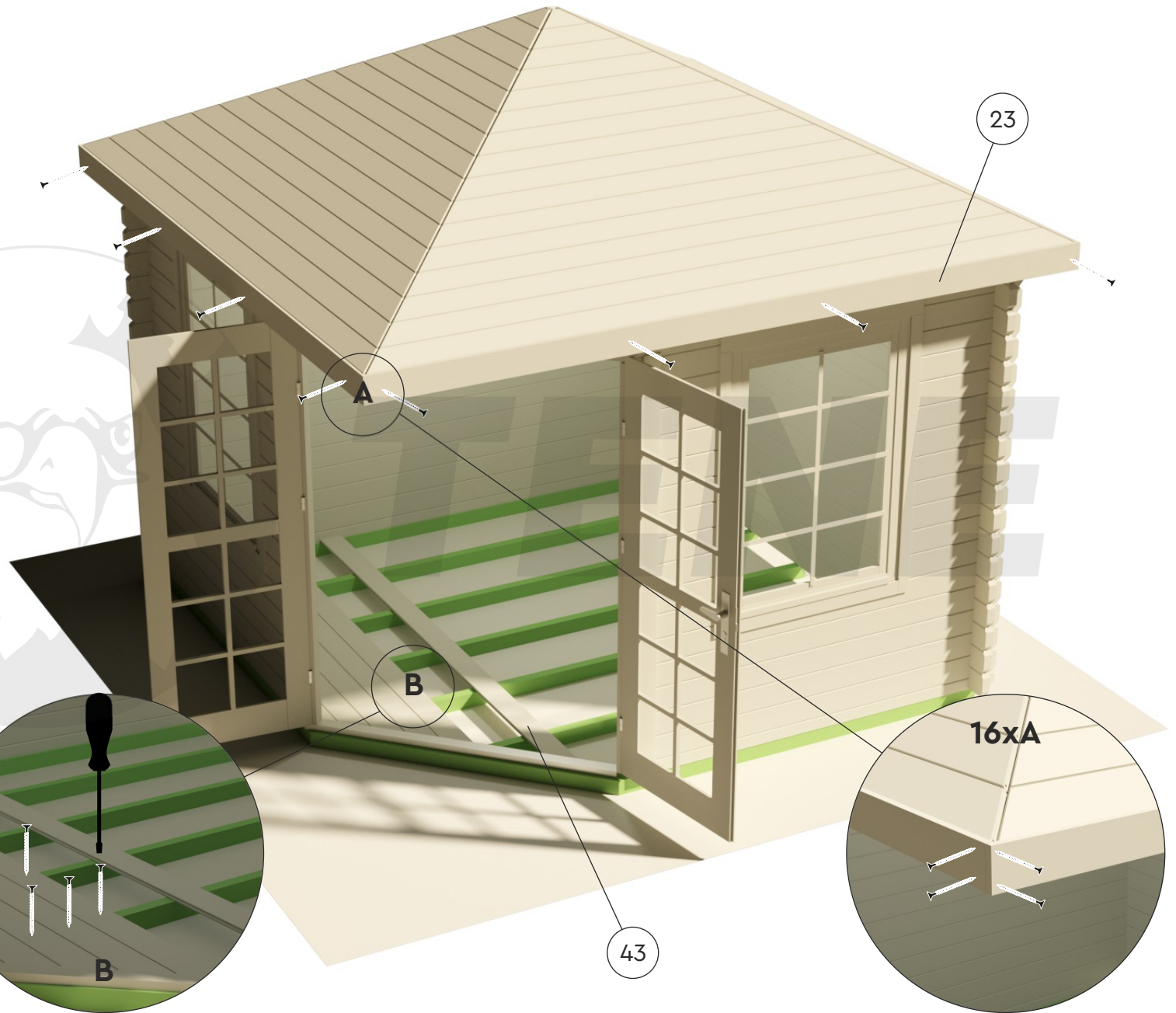

VICTORIA B 40

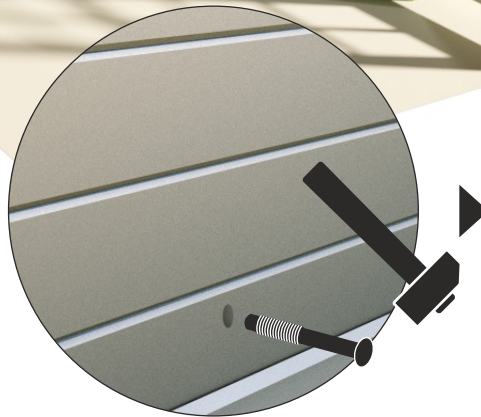
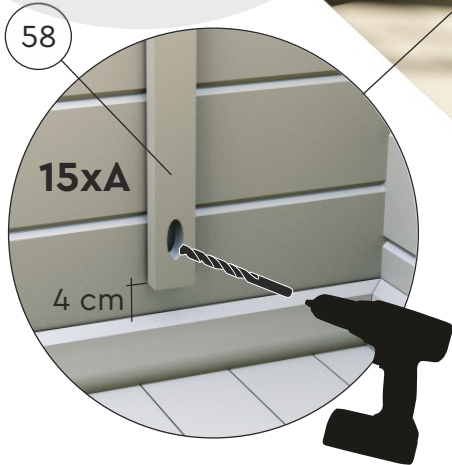
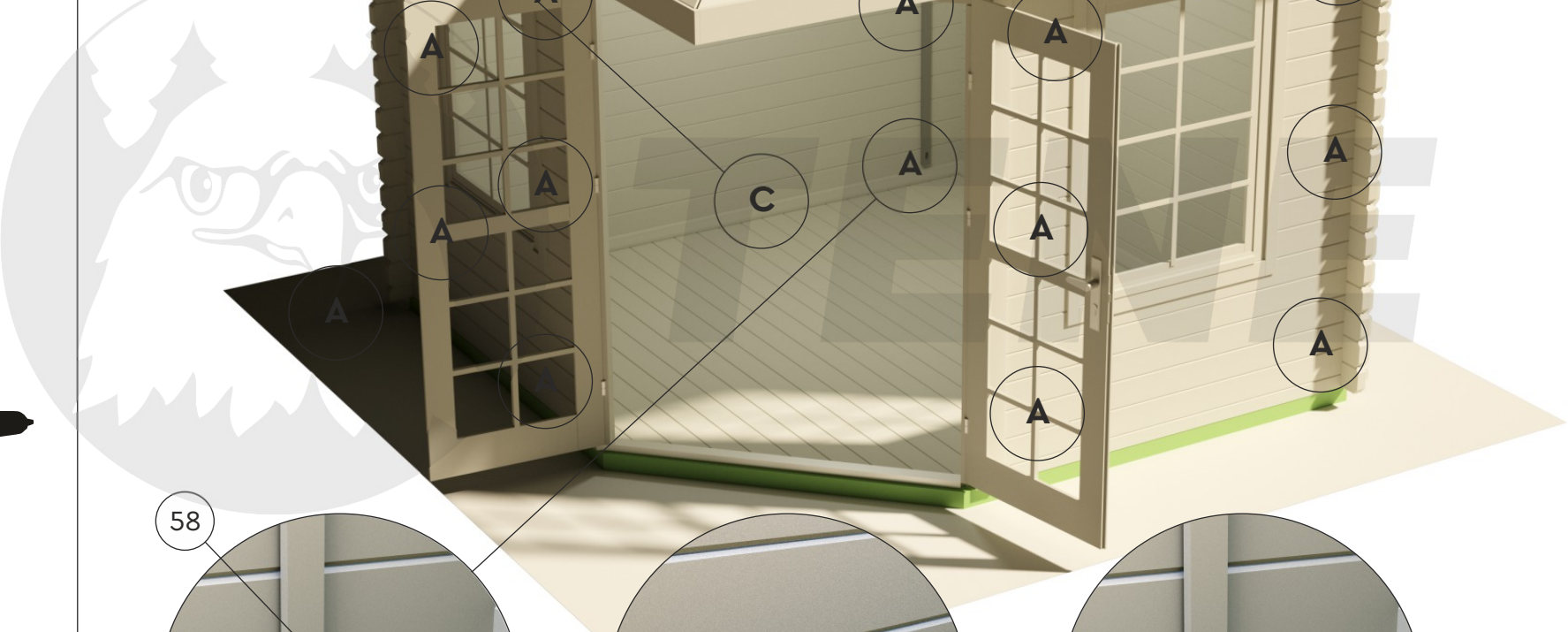
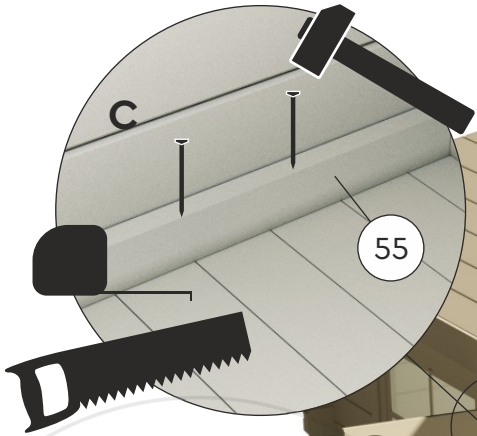
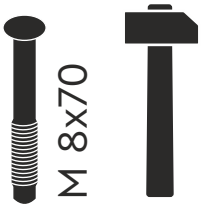
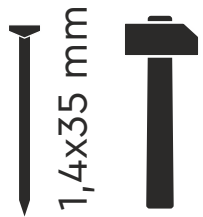
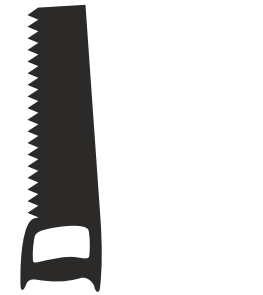

VICTORIA B 40

